

Satel®

abax2

ACU-280

ABAX 2 wireless system controller

CE

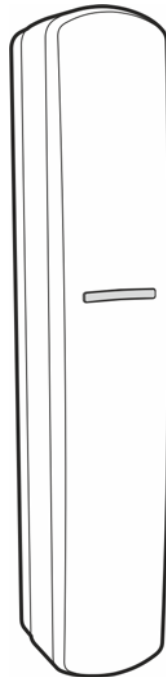

Firmware version 6.00

acu-280_en 03/19

SATEL sp. z o.o. • ul. Budowlanych 66 • 80-298 Gdańsk • POLAND

tel. +48 58 320 94 00

www.satel.eu

IMPORTANT

The device should be installed by qualified personnel.

Prior to installation, please read carefully this manual in order to avoid mistakes that can lead to malfunction or even damage to the equipment.

Disconnect power before making any electrical connections.

Changes, modifications or repairs not authorized by the manufacturer shall void your rights under the warranty.

The rating plate of the device is located on the enclosure base.

SATEL aims to continually improve the quality of its products, which may result in changes in their technical specifications and software. Current information about the changes being introduced is available on our website.

Please visit us at:
<http://www.satel.eu>

Hereby, SATEL sp. z o.o. declares that the radio equipment type ACU-280 is in compliance with Directive 2014/53/EU. The full text of the EU declaration of conformity is available at the following internet address: www.satel.eu/ce

The following symbols may be used in this manual:



- note,



- caution.

CONTENTS

1	Introduction	3
2	Features	3
3	Electronics board	4
3.1	Terminals	4
3.2	DIP-switches	5
3.2.1	Selecting the controller operating mode	5
3.2.2	Address setting [expander of wireless devices for the INTEGRA / INTEGRA Plus control panel]	5
4	Installation of the controller	6
4.1	Selecting a mounting location	6
4.2	Preparing the cabling	6
4.3	Installation of enclosure	6
4.4	Setting DIP switches	8
4.5	Connecting the wires	8
4.6	Connecting the power supply and starting the controller	9
5	Wireless devices supported by the controller	9
5.1	Devices	9
5.2	Keypads	10
5.3	Keyfob	10
6	Installation of ABAX 2 wireless devices	10
6.1	Registering devices to the controller	11
6.1.1	Expander of wireless devices for the INTEGRA / INTEGRA Plus control panel ..	11
6.1.1.1	Adding new wireless devices	13
6.1.1.2	Removing wireless devices	15
6.1.2	Expander of wireless devices for the VERSA / VERSA Plus / VERSA IP control panel	16
6.1.2.1	Adding new wireless devices	16
6.1.2.2	Removing wireless devices	17
7	Configuring the ABAX 2 system	18
7.1	Controller settings	19
7.2	Functions	20
7.3	Device settings	21
7.3.1	Configuring devices using the DLOADX program	23
7.3.2	Configuring devices using the LCD keypad	25
7.4	Specific character of the operation of wireless devices	29
7.4.1	Wireless detectors	29
7.4.2	Wireless sirens	30
7.4.3	Wireless expanders of hardwired zones and outputs	30
7.4.4	Wireless 230 V AC controllers	31
7.4.5	Radio signal repeater	31
8	APT-200 keyfobs	31
8.1	Keyfobs in the INTEGRA / INTEGRA Plus system	31
8.1.1	Keyfob management using the DLOADX program	33
8.2	Keyfobs in the VERSA / VERSA Plus / VERSA IP system	33
8.2.1	Keyfob management using the DLOADX program	34
9	ABAX 2 Soft program	35

9.1	Description of the program	35
9.1.1	Menu bar in the program.....	35
9.1.2	Additional menu	36
9.2	Establishing connection between the program and the controller.....	36
9.3	Status	37
9.3.1	Comm. history.....	39
9.4	Keyfob state.....	40
10	Controller firmware update.....	41
10.1	Updating the firmware of ABAX 2 wireless devices	41
11	Restoring the controller factory settings.....	42
12	Specifications.....	42

1 Introduction

The ACU-280 controller enables expansion of the alarm system by adding the ABAX 2 wireless devices. It can work as expander of wireless devices for SATEL alarm control panels:

- INTEGRA and INTEGRA Plus (firmware version 1.19 or newer),
- VERSA, VERSA Plus and VERSA IP (firmware version 1.09 or newer).



The controller does not support the ABAX wireless devices.

The ABAX 2 system offers two-way communication. All transmissions are acknowledged, which ensures that the information has been received and makes it possible to check the presence of devices in the system in real time. Configuration of settings, testing and updating of the firmware of wireless devices are carried out via radio and, consequently, do not require removal of their enclosure.

2 Features

- Support for up to 48 ABAX 2 wireless devices (the number of supported devices depends on the configuration).
- Support for ABAX 2 wireless keypads:
 - up to 4 INT-KWRL2 keypads,
 - up to 6 VERSA-KWRL2 keypads.
- Support for APT-200 keyfobs (the number of supported keyfobs depends on the maximum number of control panel users).
- AES standard encrypted two-way radio communication in the 868 MHz frequency band.
- Transmission channel diversity – 4 channels for automatic selection of the one that will enable transmission without interference with other signals in the 868 MHz frequency band.
- Communication bus for connecting the controller to a SATEL control panel.
- Controller firmware update capability.
- Ability to remotely update the firmware of wireless devices (except for the ASD-250 wireless smoke detector).
- Tamper protection against enclosure opening.

3 Electronics board

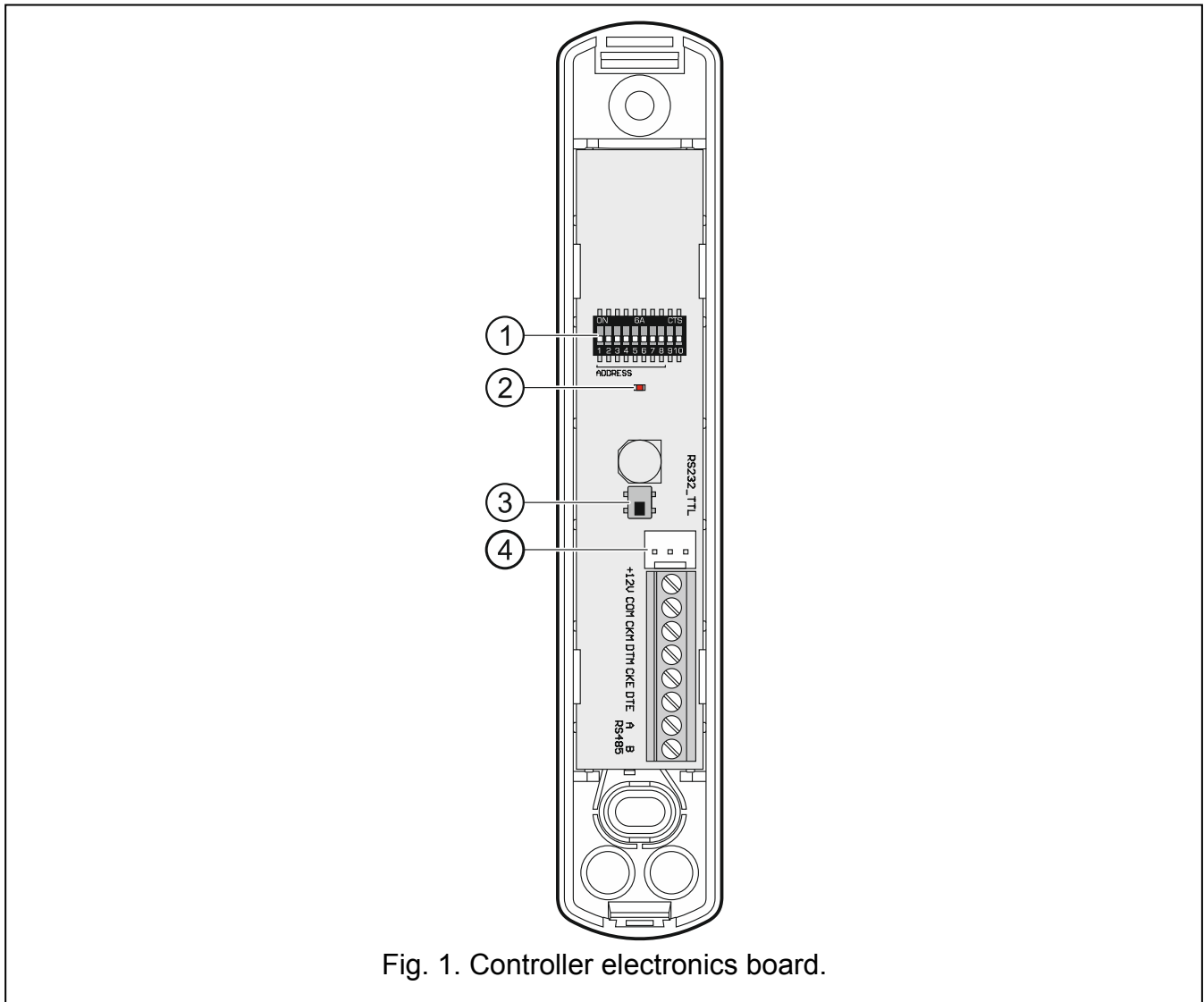

Fig. 1. Controller electronics board.

- ① DIP-switches.
- ② LED indicating the status of communication with the control panel:
ON – no communication with the control panel,
flashing – communication with the control panel OK.
- ③ tamper switch.
- ④ RS-232 port (TTL standard).

3.1 Terminals

+12V	- power input.
COM	- common ground.
CKM	- keypad bus clock.
DTM	- keypad bus data.
CKE	- expander bus clock.
DTE	- expander bus data.
A RS485 B	- terminals provided for future applications (RS-485).

3.2 DIP-switches

Using the DIP-switches, you can:

- define the controller operating mode,
- set the controller address (operating mode: expander of wireless devices for the INTEGRA / INTEGRA Plus control panel).

3.2.1 Selecting the controller operating mode

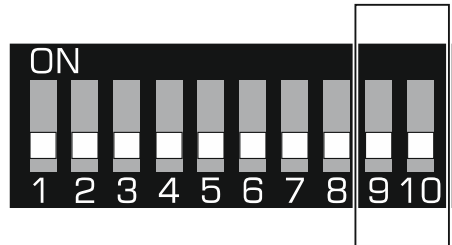

Fig. 2. Switches defining the controller operating mode.

Switches 9 and 10 (Fig. 2) define the controller operating mode – see Table 1.

Controller operating mode	DIP-switch	
	9	10
Expander of wireless devices for the INTEGRA / INTEGRA Plus control panel	OFF	OFF
Expander of wireless devices for the VERSA / VERSA Plus / VERSA IP control panel	OFF	ON

Table 1.

3.2.2 Address setting [expander of wireless devices for the INTEGRA / INTEGRA Plus control panel]

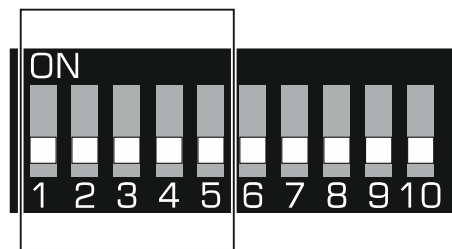

Fig. 3. DIP switches for setting address when the controller is connected to the INTEGRA / INTEGRA Plus control panel.

Switches 1-5 (Fig. 3) are used to set the address when the controller is connected to the INTEGRA / INTEGRA Plus control panel (in the other operating modes, the settings of switches 1-5 are irrelevant). Numerical value is assigned to each switch. In OFF position, the value is 0. Numerical values assigned to individual switches in ON position are presented in Table 2. The sum of numerical values assigned to switches 1-5 constitutes the address set in the device. The address must be different than that set in the other devices connected to the expander bus of the control panel.

DIP-switch	1	2	3	4	5
Number	1	2	4	8	16

Table 2.



If the controller is to be connected to the control panel to which an ABAX 2 / ABAX controller is already connected, it is recommended that the address to be set in the new controller be higher than that in the controller already connected to the control panel.

4 Installation of the controller



Disconnect power before making any electrical connections.

Be careful during installation to avoid damage to the components located on the controller electronics board.

4.1 Selecting a mounting location

The controller should be installed indoors, in spaces with normal air humidity. Prior to installation you should plan the arrangement of all ABAX 2 wireless devices which are to be operated by the controller. Select the installation place so that these devices are located within the controller operating range. Remember that thick walls, metal partitions, etc. will reduce the range of the radio signal. It is recommended that the controller be mounted high above the floor. This will allow you to get a better range of radio communication and avoid the risk of the controller being accidentally covered by people moving around the premises. Installing the device in close vicinity of electrical systems is not recommended, since it can adversely affect the range of radio signal.

Several ABAX 2 / ABAX wireless system controllers can work within each other's range. The number of wireless devices working within each other's operating range depends on the frequency of periodical communication. The higher the frequency of communication, the lesser number of devices can work within each other's range.

4.2 Preparing the cabling

Run the cables to be used to connect the controller to the control panel or other devices to the controller's installation location. For power cables, use flexible conductors with cross-sectional area of 0.5-0.75 mm². Do not lay the cables in immediate vicinity of the low-voltage electrical network wires, especially those used for supplying the high-power equipment (such as electric motors).

4.3 Installation of enclosure

The description below applies to the enclosure in which the ACU-280 controller is sold.

1. Open the controller enclosure (Fig. 4). The enclosure opening tool, shown in the illustration, is included in the detector delivery set.
2. Place the enclosure base against the wall and mark location of the mounting holes. Set the enclosure so that the cable entry opening is situated at the bottom of the enclosure or at the base.

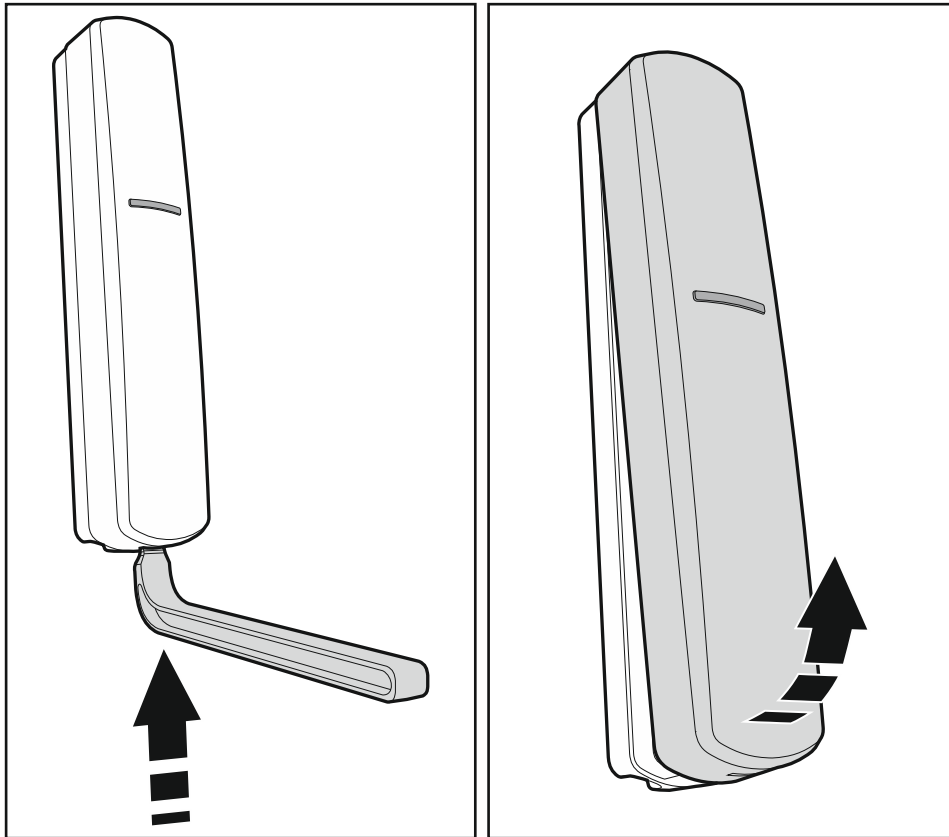

Fig. 4. Opening the enclosure.

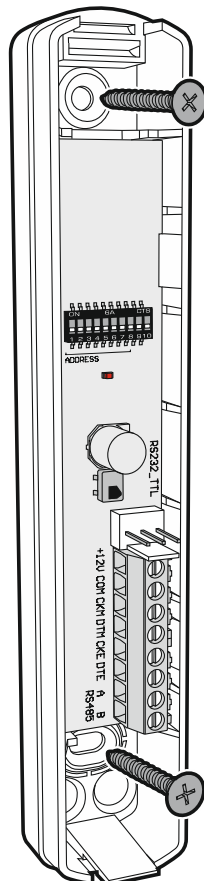

Fig. 5. Installation of enclosure base.

3. Drill holes for wall plugs (anchors) in the wall.
4. Make the cable entry opening at the base. The opening diameter must be larger than 5 mm. The finished opening must not have sharp edges.
5. Run the cables through the prepared opening (power cables, cables connecting the controller with the control panel or other devices, etc.).
6. Using wall plugs and screws, secure the enclosure base to the wall. The wall plugs delivered with the device are intended for concrete, brick, etc. For other types of surface (drywall, styrofoam), use the appropriately selected wall plugs. When installed, the device must withstand a pull-off force of at least 50 N.

4.4 Setting DIP switches

Using the DIP switches (see “DIP-switches” p. 5):

1. Define the controller operating mode (switches 9 and 10).
2. Set the controller's address if the controller is to be connected to the INTEGRA / INTEGRA Plus control panel (switches 1-5).

4.5 Connecting the wires



Protect the wiring against contact with sharp edges or else they can damage the insulation of cables.

Depending on the control panel to which the controller is to be connected:

INTEGRA / INTEGRA Plus: connect the CKM, DTM, CKE, DTE and COM terminals to the corresponding terminals of the control panel communication buses (Fig. 6).

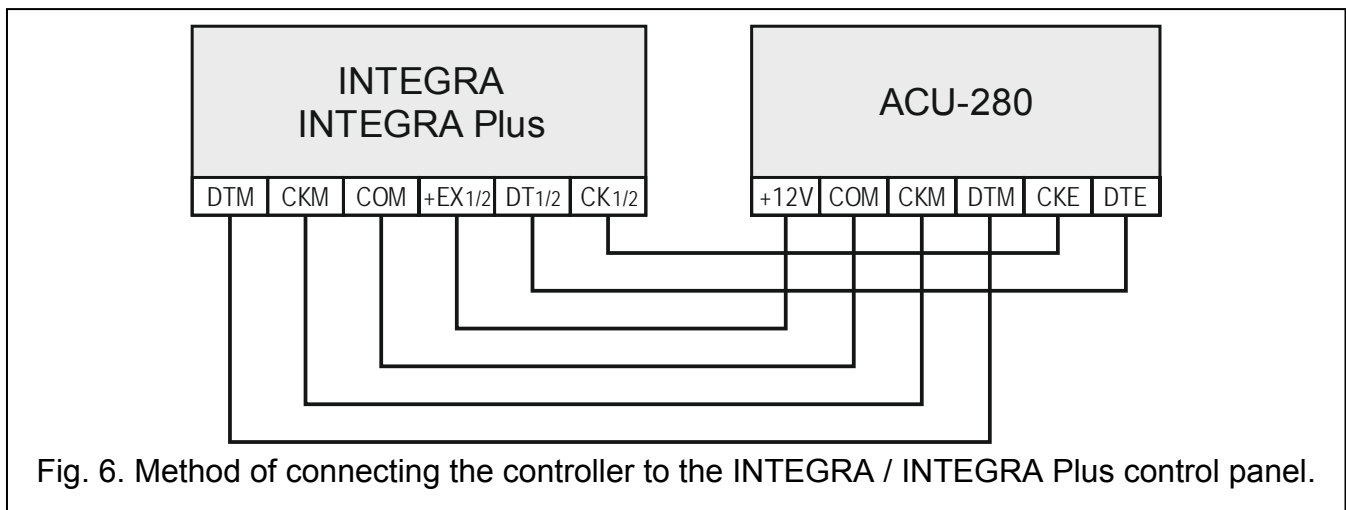

VERSA / VERSA Plus / VERSA IP: connect the CKE, DTE and COM terminals to the corresponding terminals of the control panel communication bus (Fig. 7).

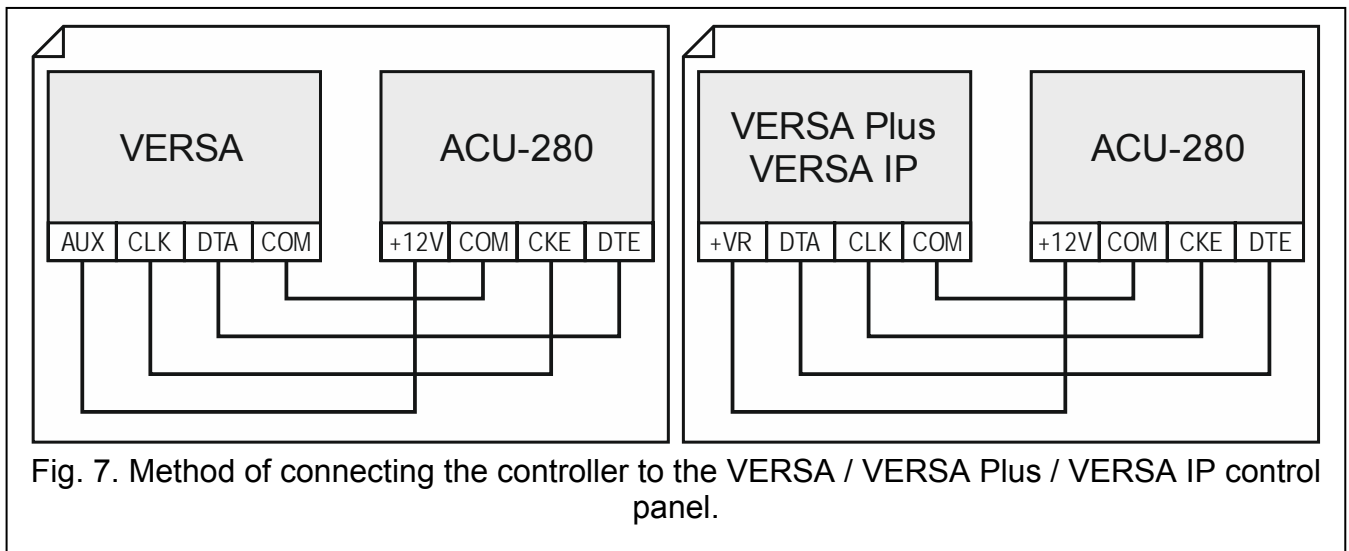

Fig. 7. Method of connecting the controller to the VERSA / VERSA Plus / VERSA IP control panel.

If you use the twisted-pair type of cable, remember that the DTM and CKM / CKE and DTE (clock and data) signals must not be sent through one pair of twisted conductors. The conductors must be run in one cable.

4.6 Connecting the power supply and starting the controller

1. Connect the power cables to the +12V and COM terminals. The controller may be powered directly from the control panel or from a power supply unit with current limitation up to 3 A.
2. Replace the cover.
3. Turn the power on. The LED indicator should come on.
4. Run the identification function in the control panel (see the control panel installer manual). The controller will be identified as ACU-100.

5 Wireless devices supported by the controller

The ABAX 2 wireless devices are divided into 3 categories:

- devices,
- keypads,
- keyfobs.

For each of these categories a separate pool of positions is provided in the controller.

5.1 Devices

Detectors

- ADD-200** - wireless outdoor dusk and temperature detector.
- AGD-200** - wireless glass-break detector.
- AOCD-260** - wireless outdoor dual technology curtain detector.
- AOD-210** - wireless outdoor dual technology motion detector.
- APD-200** - wireless passive infrared detector.
- APD-200 Pet** - wireless passive infrared detector with pet immunity up to 20 kg.
- APMD-250** - wireless dual technology motion detector.
- ASD-200** - wireless smoke and heat detector.

- ASD-250** - wireless smoke detector.
- AXD-200** - wireless multipurpose detector, which can work as:
 - AFD-200** - water flood detector,
 - AMD-200** - magnetic contact,
 - AMD-201** - dual channel magnetic contact,
 - AMD-202** - magnetic contact with input for roller shutter detector,
 - ARD-200** - reorientation detector,
 - ATD-200** - temperature detector,
 - AVD-200** - shock detector and magnetic contact.

Sirens

- ASP-200** - wireless outdoor siren.
- ASP-215** - wireless indoor siren.

Hardwired zone / output expanders

- ACX-210** - miniature hardwired zone / output expander.
- ACX-220** - hardwired zone / output expander.

Controllers

- ASW-200** - wireless 230 V AC controller.
- ASW-210** - flush-mounted wireless two-channel 230 V AC controller.

Other devices

- APB -200** - wireless panic button.
- ARF-200** - radio signal level tester.
- ARU-200** - radio signal repeater.

5.2 Keypads

INT-KWRL2 – wireless keypad for operating the INTEGRA / INTEGRA Plus control panel.

VERSA-KWRL2 – wireless keypad for operating the VERSA / VERSA Plus / VERSA IP control panel.

5.3 Keyfob

APT-200 – bidirectional keyfob.



| *Keyfobs are discussed in a separate section (p. 31).*

6 Installation of ABAX 2 wireless devices

After the controller has been installed, you can begin installation of the ABAX 2 wireless devices. Before installing a device, check the level of radio signal received by the device from controller and by the controller from device at the planned installation place. The ARF-200 tester is a useful tool to check the signal level. The level of signal received by device/controller may not be lower than 40%. You can only install the device at the planned location after making sure that the level of the radio signal is correct. If the radio signal level at the planned installation place is too low, select another installation location. Sometimes it is sufficient to move the device ten or twenty centimeters to obtain a significant improvement of signal quality.

For detailed information about installation of individual devices, please refer to the manuals of the respective products.

6.1 Registering devices to the controller

Each wireless device, including the ARF-200 tester, must be registered to the controller.



Before adding a device that was previously registered to the ABAX / ABAX 2 system, you must restart it (remove the battery / power the device off for 30 seconds).

When registering a device, you must enter its serial number. The serial number sticker is affixed to the device (location of the sticker is indicated in the manual of the device). The serial number of each ARF-200 tester is 0000500.

When registered, some devices will occupy two or more positions on the list. Therefore, the actual number of devices that can be registered depends on how many positions will be taken up by individual devices. For example, the expander ACX-220 can take up 4 positions. After registering it to the controller, the pool of positions for further devices will decrease by 4 (e.g. if there were 48 positions available before registering the expander, 44 positions will remain after registering the expander, i.e. you will still be able to register up to 44 devices).



In case of many devices that occupy two or more positions on the device list, you can select how many positions are to be occupied when registering them to the controller.

6.1.1 Expander of wireless devices for the INTEGRA / INTEGRA Plus control panel



Data on wireless devices are stored in the controller. If you connect to the control panel a controller:

- with registered devices – during identification procedure, these devices will be automatically assigned to the system zones / outputs.*
- with registered keypads – during identification procedure, the keypads will be added to the system. However, if their addresses coincide with those of other devices installed in the system, the identification procedure will be unsuccessful.*

Most of the ABAX 2 wireless devices are identified in the alarm system by the names known from the ABAX system.

For information about registering the INT-KWRL2 keypad, consult the keypad manual.

To add or delete devices, you can use the DLOADX program or LCD keypad (for more information on the DLOADX program and LCD keypads, refer to the control panel manuals).

The number of devices you can register to the controller depends on the control panel (INTEGRA 24 – up to 16; INTEGRA 32 – up to 24; other control panels – up to 48). Each position on the device list represents one wireless zone or one wireless zone and one output.

When adding and removing the wireless devices, remember that the identification function registers zones and outputs by groups of 8. Already after adding one wireless device which takes up 1 zone, the control panel will reserve 8 zones in the system for wireless devices. The LCD keypad makes it possible to select the zone to which that device will be assigned. Observe continuity, i.e. avoid leaving any gaps in the list, which will later reduce the number of available zones in the system. Remember to preserve continuity also when removing wireless devices. For example, if the devices registered in the controller occupy 9 positions on the list, then 16 zones (2x8) are reserved in the system. After removal of the device which occupied position 7 on the list, there will still be 16 zones (2x8) reserved in the system for wireless devices, although 8 positions are actually taken up on the list of wireless devices (see: Table 3). In such a case, it is recommended that the last devices be removed from the

list and then added to the system again, so as to fill up the gap in the list and reduce the number of zones reserved for wireless devices.

In case of devices which, in addition to zones, also take up outputs, it is recommended that you add them to the system first. This will allow you to maintain the continuity of use of not the zones alone, but the outputs as well.

In some cases, the gaps in the list of zones/outputs cannot be avoided. It applies to situation when the number of zones/outputs, which is used by the devices, is not a multiple of 8.

For each group of 8 zones/outputs, one address on the expander bus is reserved. The controller can occupy from 1 to 6 addresses. This must be taken into account at the system design stage and sufficient number of free addresses must be left for the controller. If, when new wireless devices have been added to the controller, it turns out that next addresses are needed, and these are taken up by other devices, successful completion of the expander identification procedure will be impossible. It will be necessary to change addresses of the devices connected to the bus.

ACU-220		INTEGRA / INTEGRA Plus				
lt.	list of devices	zones		outputs		
		No	device	No	device	
1	APD-200 detector	8	17	APD-200 detector	17	unused/unavailable
2	APD-200 detector		18	APD-200 detector	18	unused/unavailable
3	AMD-200 detector		19	AMD-200 detector	19	unused/unavailable
4	AMD-200 detector		20	AMD-200 detector	20	unused/unavailable
5	AMD-201 detector		21	AMD-201 detector	21	unused/unavailable
6	^		22	AMD-201 detector	22	unused/unavailable
7			23	unused/unavailable	23	unused/unavailable
8	ASP-200 siren		24	ASP-200 siren	24	ASP-200 siren
9	^	8	25	ASP-200 siren	25	ASP-200 siren
10			26	unused/unavailable	26	unused/unavailable
11			27	unused/unavailable	27	unused/unavailable
12			28	unused/unavailable	28	unused/unavailable
13			29	unused/unavailable	29	unused/unavailable
14			30	unused/unavailable	30	unused/unavailable
15			31	unused/unavailable	31	unused/unavailable
16			32	unused/unavailable	32	unused/unavailable

Table 3.

ACU-220		INTEGRA / INTEGRA Plus				
lt.	list of devices	zones		outputs		
		No	device	No	device	
1	ASP-200 siren	8	17	ASP-200 siren	17	ASP-200 siren
2	^		18	ASP-200 siren	18	ASP-200 siren
3	APD-200 detector		19	APD-200 detector	19	unused/unavailable
4	APD-200 detector		20	APD-200 detector	20	unused/unavailable
5	AMD-200 detector		21	AMD-200 detector	21	unused/unavailable
6	AMD-200 detector		22	AMD-200 detector	22	unused/unavailable
7	AMD-201 detector		23	AMD-201 detector	23	unused/unavailable
8	^		24	AMD-201 detector	24	unused/unavailable

Table 4.

Table 3 shows how the wireless devices should not be registered. The first siren output takes up position 8, and the second output occupies position 9. As a result, 16 outputs have been reserved for wireless devices in the system, although actually only 2 are used (the eighth output in the first group of 8 outputs and the first output in the second group of 8 outputs). For devices taking up 8 positions, the system must reserve 16 zones and 16 outputs as well as 2 addresses. Table 4 shows an example of how to correctly register the same devices (compare also Fig. 8). For 8 devices, the system has reserved 8 zones and 8 outputs as well as 1 address.

Module: ACU-120/270, address:13

version: 6.00 2019-04-02

Name: ACU-100 (2Dh)

Tamper signaled in part.: 1: Reception

No auto-reset after three module tamper alarms

Communication period
 12sec. 24sec. 36sec.

Higher sensitivity for jamming detection No automatic update of wireless devices firmware

Zones/Outputs | INT-KWRL

No.	Name	Type	Device type	Serial number	ARU	Always active	Configuration	Filter	Temp. corr.	ECO
1	OUT:41 Z:17	ASP-100 acoust. ASP-100 acoust. No alarm action (with TAMPER)	Burglary ^ (state signaling)	ASP-100 (siren)	0005650		1: Sound 1 2: time 3 min.	40		
2	OUT:42 Z:18	ASP-100 optic. ASP-100 optic. No alarm action (with TAMPER)	Burglary ^ (state signaling)	(flash)						
3	Z:19	APD-100 corridor	Interior delayed (with TAMPER)	APD-100. (PIR PET)	0000345		1-0: Sensitivity 0		2.0°C	
4	Z:20	APD-100 l. room	Interior delayed (with TAMPER)	APD-100. (PIR PET)	0000639		1-0: Sensitivity 0		1.0°C	
5	Z:21	AMD-100 door	Entry/Exit (with TAMPER)	AMD-101.(Magn. contact)	0003829	X	0:Bottom cont 0		0.0°C	
6	Z:22	L. room window 1	Perimeter (with TAMPER)	^ (NC input)						
7	Z:23	L. room window 2	Perimeter (with TAMPER)	AMD-100.(Magn. contact)	0001934	X	1:Side contac 0		0.0°C	
8	Z:24	L. room window 3	Perimeter (with TAMPER)	AMD-100.(Magn. contact)	0000523		0:Bottom cont 0		0.0°C	

Fig. 8. DLOADX program: the list of wireless devices registered in the controller connected to INTEGRA / INTEGRA Plus control panel.

6.1.1.1 Adding new wireless devices

DLOADX program

You can add a wireless device in the “Structure” window, “Hardware” tab, after clicking on the name of the controller on the device list, and then on the “Zones/Outputs” tab

The device being added is assigned to zones and outputs automatically (to the first unoccupied zones / outputs from the pool reserved for the controller).

1. Click on the “Read” button. The data related to wireless devices will be read from the controller (these data are not read after clicking on the  button in the main menu).

2. Click on the “New device” button.

3. The “New device” window will open.

4. Enter the serial number of the device being added in the “Serial number” field.

5. Power on the device (install the battery in the device, turn on the device power, etc.).

6. A message will confirm that the device has been added (unless you have entered an invalid serial number, of which the message will inform you).

6.1. Device type will be displayed.

6.2. A new name of the zone to which the device is to be assigned will be displayed. You can change the name. If the device occupies two or more positions on the device list,

the same name will be given to the other zones. If the device is to be assigned to outputs, the outputs will be given the same name.

- 6.3. For some devices you can select if the device is to occupy one or two positions on the list of devices.
7. Click on the “OK” button.
8. The “New device” window will close.
9. The new device will be displayed on the list of devices.
10. Click on the “identification” button (see Fig. 9). The new wireless zones / outputs will not be available in the alarm system until the procedure of expander identification is finished.

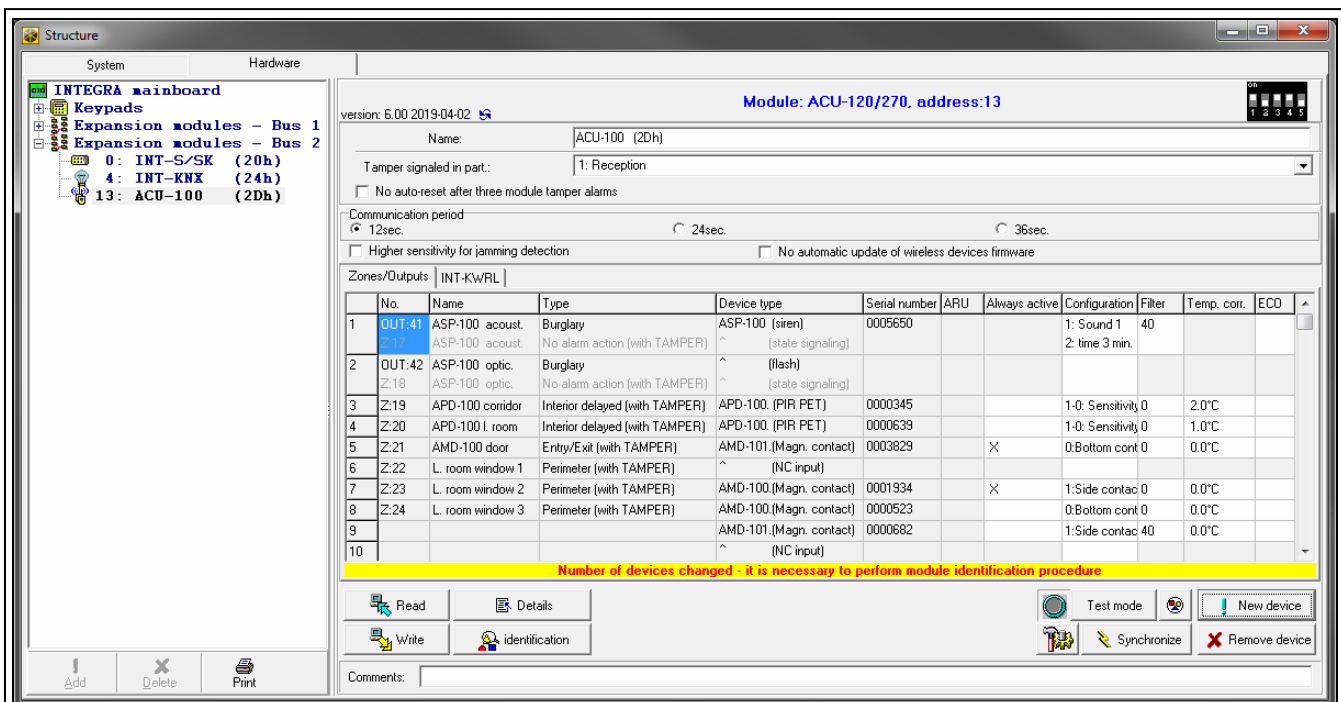

Fig. 9. DLOADX program: information displayed after registration of a new device to the controller connected to the INTEGRA / INTEGRA Plus control panel.

LCD keypad

You can add wireless devices in service mode, using the “New device” function (►“Structure” ►“Hardware” ►“Expanders” ►“Settings” ►[controller name] ►“New device”).

When adding a device you can select the alarm system zone to which you want to assign the device. It can be one of the unoccupied zones from the pool reserved for the controller. If the device takes up more than one position on the list of devices, additional zones will be assigned to the device automatically (these will be the zones following the selected one). To the outputs, the device is assigned automatically (to the first unoccupied outputs from the pool reserved for the controller).

1. Start the “New device” function.
2. When the “Device serial number:” is displayed, enter the serial number of the device being added.
3. Press #.
4. When the “Open device tamper” command is displayed, power on the device (insert the battery into the device, turn on the device power, etc.).
5. Type and serial number of the device will be displayed (if a message is displayed instead to inform you that the entered serial number is invalid or the device is already registered, press * to quit the function).

6. Press the key 1.
7. If you can select whether the device will take up one or two positions (channels) on the list of devices, a special message will inform you about it. Press the key 1 (the device will occupy 1 position) or the key 2 (the device will occupy 2 positions).
8. Use the ▼ and ▲ keys to select the zone to which you want to assign the device.
9. Press #.
10. A message will be displayed to inform you that expander identification procedure has been started.
11. When the procedure is finished, the new name of the zone / output to which the device has been assigned will be displayed. You can change that name.
12. Press #.
13. If the device occupies two or more zones / outputs, the name giving procedure is repeated for them.

6.1.1.2 Removing wireless devices

DLOADX program

You can remove a wireless device in the “Structure” window, “Hardware” tab, after clicking on the name of the controller on the device list, and then on the “Zones/Outputs” tab

1. Click on the “Read” button. The data related to wireless devices will be read from the controller (these data are not read after clicking on the  button in the main menu).
2. Click on the device you want to remove (if the device occupies two or more positions on the list, you can click on any of them).
3. Click on the “Remove device” button.
4. The “Confirm” window will open.
5. Click on the “Yes” button.
6. The “Confirm” window will close.
7. Click on the “identification” button. The wireless zones / outputs will not be removed from the alarm system until the expander identification procedure is finished.

LCD keypad

You can remove a wireless device in the service mode, using the “Remove device” function (►“Structure” ►“Hardware” ►“Expanders” ►“Settings” ►[*controller name*] ►“Remove device”).

1. Start the “Remove device” function.
2. List of wireless zones will be displayed.
3. Use the ▼ and ▲ keys to select the zone to which the device you want to remove is assigned.
4. Press #.
5. A prompt will be displayed asking you whether to remove the device (type and serial number of the device will be displayed).
6. Press the key 1.
7. A message will be displayed to inform you that the expander identification procedure has started.
8. When the procedure is finished, the list of wireless zones will be displayed again.

6.1.2 Expander of wireless devices for the VERSA / VERSA Plus / VERSA IP control panel



Data on wireless devices are stored in the controller. If you connect to the control panel a controller:

- *with registered devices – during identification procedure, these devices will be automatically assigned to the system zones / outputs.*
- *with registered keypads – during identification procedure, the keypads will be added to the system. However, if their addresses coincide with those of other devices installed in the system, the identification procedure will be unsuccessful.*

Most of the ABAX 2 wireless devices are identified in the alarm system by the names known from the ABAX system.

For information about registering the VERSA-KWRL2 keypad, consult the keypad manual.

To add or delete devices, you can use the DLOADX program or LCD keypad (for more information on the DLOADX program and LCD keypads, refer to the control panel manuals).

You can register up to 30 devices to the controller. Each position on the device list represents one wireless zone or one wireless zone and one output.

6.1.2.1 Adding new wireless devices

When adding devices you can select the alarm system zone to which you want to assign a device. It can be any zone to which no wireless device is still assigned. If the device takes up more than one position on the list of devices, additional zones will be assigned to the device automatically (these will be zones immediately following the selected one).

If the device is to be also assigned to an output, the output number will be the same as that of the selected zone.



The control panel does not support wireless outputs with numbers from 13 to 30. Therefore it is not recommended that you assign any devices that are at the same time assigned to outputs (e.g. sirens, controllers, etc.) to the zones from 13 to 30.

DLOADX program

You can add a wireless device in the “VERSA – Structure” window, “Hardware” tab, after clicking on the name of the controller on the device list, and then on the “Zones/Outputs” tab.

1. Click on the “Read” button. The data related to wireless devices will be read from the controller (these data are not read after clicking on the  button in the main menu).
2. Click on the zone to which a new wireless device is to be assigned (you can also select the zone later in the “New wireless dev.” window).
3. Click on the “New device” button.
4. The “New wireless dev.” window will open.
5. Enter the serial number of the device being added in the “Serial number” field.
6. Power on the device (install the battery in the device, turn on the device power, etc.).
7. A message will confirm that the device has been added (unless you have entered an invalid serial number, of which the message will inform you).
 - 7.1. Device type will be displayed.
 - 7.2. A new name of the zone to which the device is to be assigned will be displayed. You can change the name. If the device occupies two or more positions on the device list,

the same name will be given to the other zones. If the device is to be assigned to outputs, the outputs will be given the same name.

- 7.3. In the “Zone” field, select the number of the zone to which you want to assign the device (if you have not done this before or if you want to change the previously selected number).
- 7.4. For some devices you can select if the device is to occupy one or two positions on the list of devices.
8. Click on the “OK” button.
9. The “New wireless dev.” window will close.
10. The new device will be displayed on the list of devices.
11. Click on the “Write” button to save changes to the controller (these data will not be saved after clicking on the  button in the main menu).

LCD keypad

You can add wireless devices in service mode, using the “New device” function (►“2.Hardware” ►“1.Kpds. & exps” ►“3.Wireless dev.” ►“1.New device”).

1. Start the “New device” function.
2. When the “Serial number” is displayed, enter the serial number of the device being added.
3. Press #.
4. When the “Open device tamper” command is displayed, power on the device (insert the battery into the device, turn on the device power, etc.).
5. Type and serial number of the device will be displayed (if nothing happens, you might have entered a wrong serial number – press * to quit the function).
6. Depending on the device:
 - if the device takes up only 1 zone or you cannot select how many positions the device is to occupy on the device list – press the key 1.
 - if you can select whether the device will take up one or two positions (channels) on the list of devices, a special message will inform you about it – press the key 1 (the device will occupy 1 position) or the key 2 (the device will occupy 2 positions).
7. Use the ▼ and ▲ keys to select the zone to which you want to assign the device.
8. Press #.
9. The new name of the zone / output to which the device has been assigned will be displayed. You can change that name.
10. Press #.
11. If the device occupies two or more zones / outputs, the name giving procedure is repeated for them.
12. In the next steps, you can configure the device settings.

6.1.2.2 Removing wireless devices

DLOADX program

You can remove a wireless device in the “VERSA – Structure” window, “Hardware” tab, after clicking on the name of the controller on the device list, and then on the “Zones/Outputs” tab.

1. Click on the “Read” button. The data related to wireless devices will be read from the controller (these data are not read after clicking on the  button in the main menu).
2. Click on the device you want to remove (if the device occupies two or more positions on the list, you can click on any of them).

3. Click on the “Delete” button.
4. The “Confirm” window will open.
5. Click on the “Yes” button.
6. The “Confirm” window will close.
7. Click on the “Write” button to save changes to the controller (these data will not be saved after clicking on the  button in the main menu).

LCD keypad

You can remove a wireless device in the service mode, using the “Remove device” function (►“2.Hardware” ►“1.Kpds. & exps.” ►“3.Wireless dev.” ►“ 3.Remove device”).

1. Start the “Remove device” function.
2. List of wireless zones will be displayed.
3. Use the ▼ and ▲ keys to select the zone to which the device you want to remove is assigned.
4. Press #.
5. A prompt will be displayed asking you whether to remove the device (type and serial number of the device will be displayed).
6. Press the key 1.

7 Configuring the ABAX 2 system

To configure the wireless system settings you can use the DLOADX program or LCD keypad (for more information on DLOADX program and LCD keypads, refer to the control panel manuals).

For the INTEGRA / INTEGRA Plus control panel:

- DLOADX program: “Structure” window →“Hardware” tab →“Expansion modules” branch →*[controller name]* (Fig. 10).
- LCD keypad:
 - system settings: service mode ►“Structure” ►“Hardware” ►“Expanders” ►“Settings” ►*[controller name]*,
 - controller name: service mode ►“Structure” ►“Hardware” ►“Expanders” ►“Names” ►*[controller name]*.

For the VERSA / VERSA Plus / VERSA IP control panel:

- DLOADX program: “VERSA – Structure” window →“Hardware” tab →“Expansion modules” branch →*[controller name]*.
- LCD keypad:
 - controller settings: service mode ►“2.Hardware” ►“1.Kpds & exps.” ►“2.Settings” ►*[controller name]*,
 - wireless devices settings: service mode ►“2.Hardware” ►“1.Kpds & exps.” ►“3.Wireless dev.”.

Names of parameters and options from the DLOADX program are used in this manual. Shown in square brackets at the description of a parameter or option is the name presented on the display of the INTEGRA / INTEGRA Plus alarm system keypad.

7.1 Controller settings

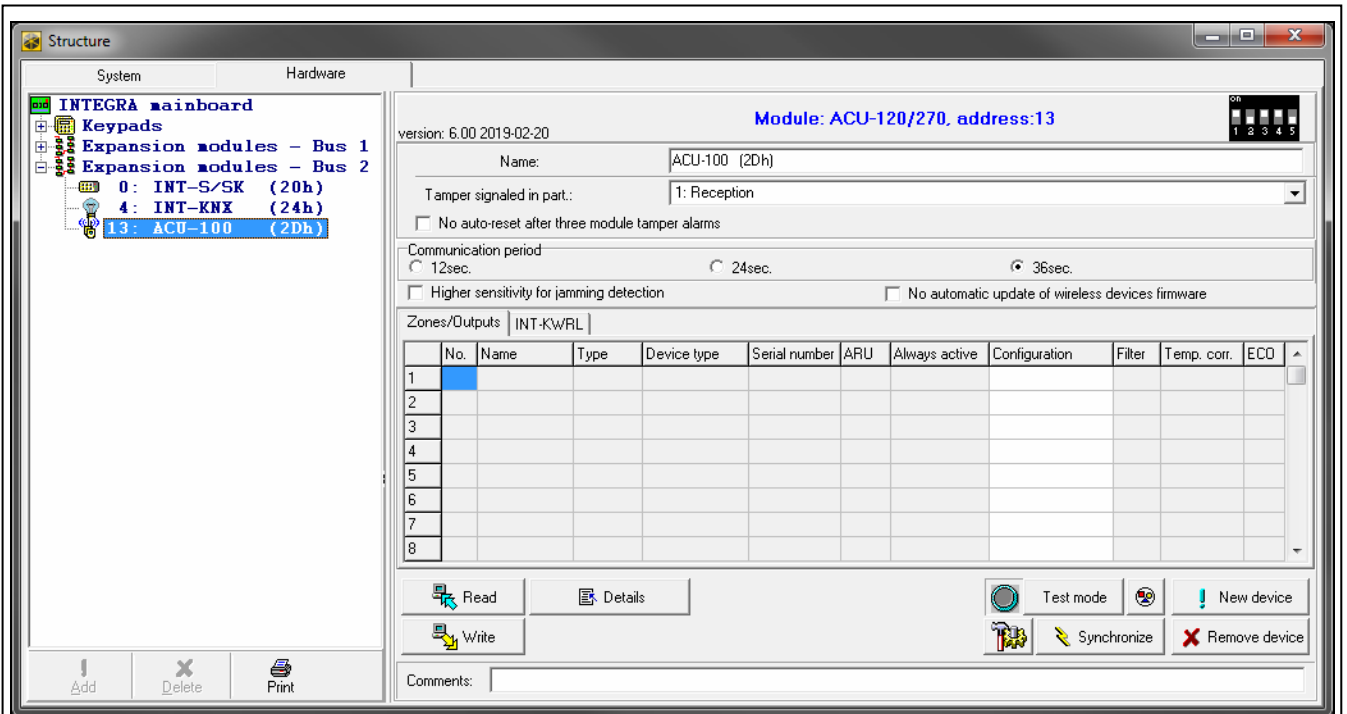

Fig. 10. DLOADX program: parameters and options of the controller connected to INTEGRA / INTEGRA Plus control panel.

Name – individual name of device (up to 16 characters).

Tamper signaled in partition [Tamper in part.] – partition where alarm will be triggered in the event of module tamper.

No auto-reset after three module tamper alarms [No autorst.3t.] – if this option is enabled, the feature reducing the number of tamper alarms from the module to three is disabled (the feature prevents multiple logging of the same events and applies to successive uncleared alarms).

Communication period [Response period] – define the time intervals at which wireless devices are to communicate with the controller. Periodical communication can take place every 12, 24 or 36 seconds. During periodical communication, the devices inform the controller about their status, and the controller sends commands to the devices (switches the detectors into active/passive mode, starts/ends test mode, changes configuration of the devices, etc.). The communication period has effect on the level of energy consumption by wireless devices: the less frequent is the communication, the lower is the energy consumption. For the battery-operated devices it means longer battery life. Moreover, when the communication takes place less frequently, more wireless devices can work within each other's operating range.



If you enable the “ECO” option for a wireless device, periodical communication between that device and the controller will take place every 3 minutes (the “Communication period” parameter will have no effect on the device operation).

Some information and commands need to be sent immediately. Therefore, additional communication takes place when the device reports tamper, when the detector reports alarm, etc.

Higher sensitivity for jamming detection [High jam sens.] – if this option is enabled, the sensitivity of detection of radio communication jamming is boosted.

No automatic update of wireless devices firmware [No updates] – if this option is enabled, the firmware of wireless devices registered in the controller is not updated automatically (see “Updating the firmware of ABAX 2 wireless devices” p. 41).

User can replace VERSA-LCDM-WRL battery – if this option is enabled, all users can replace battery in the VERSA-KWRL2 wireless keypads (for 3 minutes after the code is entered and confirmed with the  key, the status of tamper switch will not be monitored on the keypad that was used to enter the code). If the option is disabled, the battery can only be replaced by the users who have access to the “Replace bat.” function in the “0.Service” submenu.

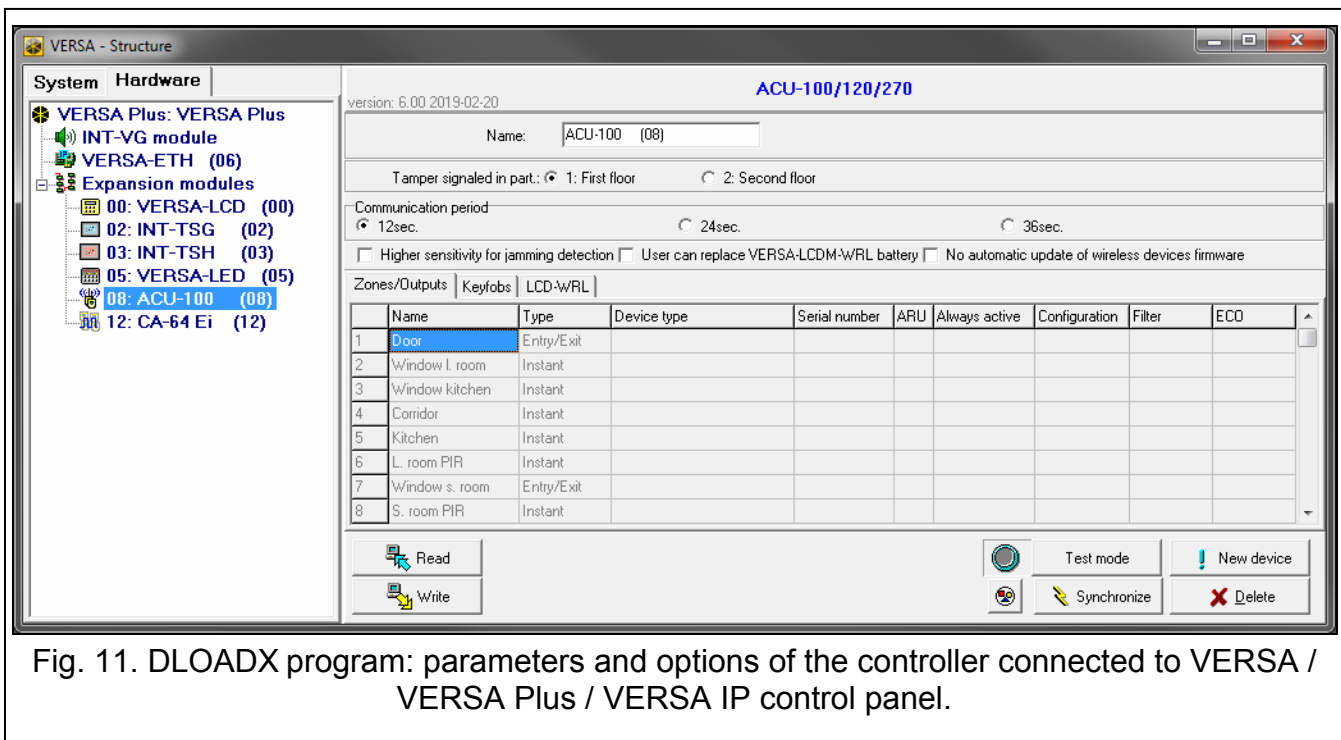

Fig. 11. DLOADX program: parameters and options of the controller connected to VERSA / VERSA Plus / VERSA IP control panel.

7.2 Functions

Test mode – to carry out diagnostics / service work, you can start the test mode in the ABAX 2 system. When the system is running in the test mode:

- detector LEDs are enabled,
- tamper signaling in the sirens is blocked.

The command to start/end the test mode is sent during periodical communication, i.e. with delay whose duration depends on the frequency of periodical communication. The test mode will be disabled automatically 30 minutes after:

- starting the test mode from the DLOADX program (the countdown of 30 minutes runs from exiting the controller settings),
- exiting the service mode in the INTEGRA / INTEGRA Plus / VERSA / VERSA Plus / VERSA IP control panel,
- closing the ABAX 2 Soft program.



As required by EN50131, the level of radio signal sent by wireless devices is lowered when the system is running in the test mode.

Synchronize – the function does not apply to the ABAX 2 system.

7.3 Device settings

ARU [Use ARU-100] – parameter available for a wireless device, if the ARU-200 repeater is registered in the controller (the controller is connected to the INTEGRA or INTEGRA Plus control panel). It allows you to define whether the device is to communicate to the controller directly, or via the selected ARU-200 repeater (several ARU-200 repeaters can be registered in the controller).

Always active [Active mode] – the option is available for the most of wireless detectors. If enabled, the detector is permanently switched over to the active mode (see „Wireless detectors” p. 29).



The wireless detectors assigned to 24-h zones are always in the active mode, therefore the “Always active” option does not have to be enabled for them.

The battery life time in the detectors switched permanently into the active mode is shorter than in those which are periodically switched to the passive mode.

Configuration [Settings] – for some devices you can configure additional parameters and options. Shown in parentheses is the device name in the ABAX 2 system (if the device is identified in the alarm system by the name known from the ABAX system). Shown in square brackets is information about the number of zone for which additional parameters are to be programmed if the device takes up more than one zone.

ADD-200 – wireless outdoor dusk and temperature detector. You can configure:

- sensitivity of the dusk sensor (detection threshold) [first zone],
- temperature parameters [second zone]:
 - threshold type: high (when the temperature rises above the defined value, alarm will be triggered) or low (when the temperature drops below the defined value, alarm will be triggered),
 - temperature,
 - tolerance.

AGD-100 (AGD-200) – wireless glass-break detector. You can configure sensitivity.

AMD-100 (AMD-200) / AMD-101 (AMD-201) – wireless magnetic contact. Do not configure the detector settings (the AMD-200 / AMD-201 detector does not have two reed switches).

AMD-102 (AMD-202) – wireless magnetic contact with input for roller shutter detector:

- do not configure the magnetic contact settings [first zone] (the AMD-202 detector does not have two reed switches).
- you can configure parameters of roller shutter input [second zone]:
 - number of pulses after which the roller shutter input will trigger alarm,
 - time period during which the defined number pulses must occur for the roller shutter input to trigger alarm.

AOCD-250 (AOCD-260) – wireless outdoor dual technology curtain detector. You can configure:

- sensitivity of the PIR sensor,
- sensitivity of the microwave sensor.

AOD-200 (AOD-210) – wireless outdoor dual technology motion detector. You can configure:

- sensitivity of the PIR sensor,
- sensitivity of the microwave sensor,
- sensitivity of the dusk sensor (detection threshold).

APD-100 (APD-200) – wireless passive infrared detector. You can configure sensitivity.

APD-100 (APD-200 Pet) – wireless passive infrared detector with pet immunity up to 20 kg:

- you can configure sensitivity,
- do not configure the pet immunity option (the APD-200 Pet detector is always immune to the movement of pets).

APMD-150 (APMD-250) – wireless dual technology detector. You can configure:

- sensitivity of the PIR sensor,
- sensitivity of the microwave sensor,
- manner of operation in the test mode.

ARD-100 (ARD-200) – wireless reorientation detector. You can configure sensitivity.

ASD-150 (ASD-250) – wireless smoke detector. You can configure:

- option to indicate alarm from other ASD-250 detectors,
- option to send alarm to other ASD-250 detectors.

ATD-100 (ATD-200) – wireless temperature detector. You can configure the temperature threshold parameters for both positions occupied by the detector (which enables two different temperature thresholds to be programmed):

- threshold type: high (when the temperature rises above the defined temperature, alarm will be triggered) or low (when the temperature drops below the defined temperature, alarm will be triggered),
- temperature,
- tolerance.

AVD-100 (AVD-200) – wireless shock detector and magnetic contact:

- do not configure the magnetic contact settings [first zone] (the AVD-200 detector does not have two reed switches).
- for the shock detector [second zone]:
 - you can configure sensitivity (registering a shock meeting the sensitivity criterion will trigger alarm),
 - do not configure the number of shocks (the AVD-200 detector does not count up the shocks).

ASP-100 (ASP-200) – wireless outdoor siren. You can configure:

- type of acoustic signaling,
- maximum duration of signaling.

ASP-205 (ASP-215) – wireless indoor siren. You can configure the signaling parameters for both positions occupied by the siren (which enables two different types of signaling to be programmed):

- maximum duration of signaling,
- type of acoustic signaling,
- optical signaling option.

ASW-100 (ASW-200) – wireless 230 V AC controller. You can select operating mode.

ASW-210 – flush-mounted wireless two-channel 230 V AC controller. You can select the operating mode of the controller inputs.

Filter [Filter] – the number of consecutive communication periods without connection between the device and the controller after which loss of communication with the device will be reported. You can enter values from 0 to 50. Entering 0 disables the check for device presence in the system.

Temp. corr. – you can correct the temperature information sent by the device by up to $\pm 3.5^{\circ}\text{C}$.

ECO – if this option is enabled, periodical communication with the device takes place every 3 minutes. Thus the battery life can be extended up to four times.



Remember that with the “ECO” option enabled for:

detectors – delay between arming / disarming and changing the detector operating mode (active / passive) can be up to three minutes,

ASP-215 siren – delay in starting / stopping the signaling can be up to three minutes.

7.3.1 Configuring devices using the DLOADX program

Before making any changes, click on the “Read” button, and after making the changes – on the “Write” button. The data on wireless devices are not read / written when you use buttons in the DLOADX main menu.

ARU

In the “ARU” column:

- leave the field blank, if the device is to communicate directly to the controller,
- enter the ARU-200 repeater number in the list of wireless devices, if the device is to communicate to the controller via the repeater (the repeater takes up two positions on the list of devices – enter the number of the first of them).

Configuration

In the “Configuration” column you can configure additional parameters and options for the ABAX 2 devices.

ADD-200

Dusk sensor – enter a number from the 1 to 16 range to determine sensitivity (1 – minimum; 16 – maximum).

Temperature sensor – enter in turn:

- letter H (high temperature threshold) or L (low temperature threshold),
- number from a range of -30 to +70 (with 0.5 accuracy) to define temperature,
- number from a range of 0.5 to 10 (with 0.5 accuracy) to define tolerance.

AGD-100 (AGD-200)

Enter a digit from the 1 to 3 range to set the sensitivity (1 – low , 2 – medium, 3 - high).

AMD-100 (AMD-200) / AMD-101 (AMD-201)

Do not configure.

AMD-102 (AMD-202)

Magnetic contact – do not configure.

Roller shutter input – enter 2 digits:

1st digit – number of pulses: from 1 to 8.

2nd digit – pulse validity: 0 (30 seconds), 1 (120 seconds), 2 (240 seconds) or 3 (unlimited duration).

AOCD-250 (AOCD-260)

Enter 2 digits:

1st digit – sensitivity of PIR sensor: from 1 to 4 (1 – minimum; 4 – maximum).

2nd digit – sensitivity of microwave sensor: from 1 to 8 (1 – minimum; 8 – maximum).

AOD-200 (AOD-210)

Enter 3 digits:

1st digit – sensitivity of PIR sensor: from 1 to 4 (1 – minimum; 4 – maximum).

2nd digit – sensitivity of microwave sensor: from 1 to 8 (1 – minimum; 8 – maximum).

3rd digit – sensitivity of dusk sensor: from 1 to 4 (1 – minimum; 4 – maximum).

APD-100 (APD-200)

Enter a digit from the 1 to 3 range to set the sensitivity (1 – low , 2 – medium, 3 - high).

APD-100 (APD-200 Pet)

Enter 2 digits:

1st digit – sensitivity: 1 (low), 2 (medium) or 3 (high),

2nd digit – pet immunity option – 0 or 1 (the entered value is irrelevant).

APMD-150 (APMD-250)

Enter 3 digits:

1st digit – sensitivity of PIR sensor: from 1 to 4 (1 – minimum; 4 – maximum).

2nd digit – sensitivity of microwave sensor: from 1 to 8 (1 – minimum; 8 – maximum).

3rd digit – the way of operation in the test mode: 0 (alarm after motion is detected by both sensors), 1 (alarm after motion is detected by PIR sensor) or 2 (alarm after motion is detected by microwave sensor).

ARD-100 (ARD-200)

Enter a number from the 1 to 16 range to determine sensitivity (1 – minimum; 16 – maximum).

ASD-150 (ASD-250)

Enter 2 digits:

1st digit – option to signal alarm from other ASD-250 detectors: 0 (disabled) or 1 (enabled).

2nd digit – option to send out alarm to other ASD-250 detectors: 0 (disabled) or 1 (enabled).

ATD-100 (ATD-200)

For each position taken by the detector, enter in turn:

- letter H (high temperature threshold) or L (low temperature threshold),
- number from a range of -30 to +70 (with 0.5 accuracy) to define temperature,
- number from a range of 0.5 to 10 (with 0.5 accuracy) to define tolerance.

AVD-100 (AVD-200)

Magnetic contact – do not configure.

Shock detector – enter 2 digits:

1st digit – sensitivity: from 1 to 8 (1 – minimum ; 8 – maximum).

2nd digit – the number of shocks – the entered value is irrelevant.

ASP-100 (ASP-200)

Enter 2 digits:

1st digit – type of acoustic signaling: from 1 to 4 – see table 5.

2nd digit – maximum duration of signaling: 1 (1 minute), 2 (3 minutes), 3 (6 minutes) or 4 (9 minutes).





1	Two sound frequencies (1450 Hz/2000 Hz) alternating within 1 second.	
2	Sound with rising frequency (from 1450 Hz to 2000 Hz) within 1 second.	
3	Sound with smoothly rising and falling frequency (1450 Hz – 2000 Hz – 1450 Hz) within 1 second.	
4	Sound with falling frequency (from 2000 Hz to 1450 Hz) within 1 second.	

Table 5. Types of acoustic signaling available in the ASP-200 siren.

ASP-205 (ASP-215)

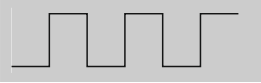
For each position taken on the list by the siren, enter 3 digits:

1st digit – maximum duration of signaling: 1 (1 minute), 2 (3 minutes), 3 (6 minutes) or 4 (9 minutes).

2nd digit – type of acoustic signaling: 0 (disabled), 1 (sound type 1), 2 (sound type 2) or 3 (sound type 3) – see table 6.

3rd digit – optical signaling: 0 (disabled) or 1 (enabled).



1	Two sound frequencies (1450 Hz/2000 Hz) alternating within 1 second.	
2	Sound with rising frequency (from 1450 Hz to 2000 Hz) within 1 second.	
3	Sound with falling frequency (from 2000 Hz to 1450 Hz) within 1 second.	

Table 6. Types of acoustic signaling available in the ASP-215 siren.

ASW-100 (ASW-200)

Enter 0 (only remote control), 1 (remote or manual control) or 2 (remote or manual control, but with option to manually block the remote control).

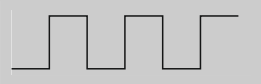
ASW-210

For each position occupied by the controller, enter 0 (relay can only be controlled via the control panel), 1 (the input enables relay to be controlled with monostable switch) or 2 (the input enables relay to be controlled with bistable switch).

7.3.2 Configuring devices using the LCD keypad

INTEGRA / INTEGRA Plus

To configure devices, use the functions: “Use ARU-100”, “Active mode”, “Settings”, “Filter” and “ECO” (service mode ► “Structure” ► “Hardware” ► “Expanders” ► “Settings” ► [controller name]). Having started the function, use the ▼ and ▲ keys to select the zone to which the wireless device is assigned and press #.

Use ARU-100

Using the ▼ and ▲ keys select whether the wireless device is to communicate to the controller directly, or via a selected repeater (the names of the zones to which the repeaters are assigned are displayed on the list).

Active mode

Press any key to define whether the detector is to be always active (· – no,  – yes).

Settings

To configure parameters and options, use the arrow keys and the number keys. For description of the settings, see the section on configuring devices from the DLOADX program.

Filter

Using the number keys, enter a number from a range of 0 to 50 to define the rules of device presence control.

VERSA / VERSA Plus / VERSA IP

You can configure the device settings:

- immediately after registering the device to the controller,
- using the “Config.device” function (service mode ► “2.Hardware” ► “1.Kpds. & exps” ► “3.Wireless dev.” ► “2.Config.device”). Having started the function, use the ▼ and ▲ keys to select the zone to which the device is assigned and press #.

The programming is performed using the “step by step” method. Described below is how to configure the devices for which additional settings are available.

AGD-100 (AGD-200)

1. Enter a number from the 0 to 50 range to define the rules of device presence control.
2. Press #.
3. Define whether the detector is to be always active by pressing any number key (· – no,  – yes).
4. Press #.
5. Enter a digit from the 1 to 3 range to define sensitivity (1 – low, 2 – medium, 3 – high).
6. Press #.

AMD-100 (AMD-200) / AMD-101 (AMD-201)

1. Enter a number from the 0 to 50 range to define the rules of device presence control.
2. Press #.
3. Define whether the detector is to be always active by pressing any number key (· – no,  – yes).
4. Press #.
5. When the reed switch settings are displayed, press # (these settings are irrelevant).

AMD-102 (AMD-202)

For the magnetic contact:

1. Enter a number from the 0 to 50 range to define the rules of device presence control.
2. Press #.
3. Define whether the detector is to be always active by pressing any number key (· – no,  – yes).
4. Press #.
5. When the reed switch settings are displayed, press # (these settings are irrelevant).

For the roller shutter input:

1. Enter a digit from the 1 to 8 range to define the number of pulses that will trigger alarm.
2. Press #.

3. Use the ▼ and ▲ keys to select the pulse validity (30, 120 or 240 seconds or unlimited duration).
4. Press #.

AOCD-250 (AOCD-260)

1. Enter a number from the 0 to 50 range to define the rules of device presence control.
2. Press #.
3. Define whether the detector is to be always active by pressing any number key (· – no,  – yes).
4. Press #.
5. Enter a digit from the 1 do 4 range to define sensitivity of the PIR sensor (1 – minimum; 4 – maximum).
6. Press #.
7. Enter a digit from the 1 do 8 range to define sensitivity of the microwave sensor (1 - minimum; 8 – maximum).
8. Press #.

AOD-200 (AOD-210)

1. Enter a number from the 0 to 50 range to define the rules of device presence control.
2. Press #.
3. Define whether the detector is to be always active by pressing any number key (· – no,  – yes).
4. Press #.
5. Enter a digit from the 1 do 4 range to define sensitivity of the PIR sensor (1 – minimum; 4 – maximum).
6. Press #.
7. Enter a digit from the 1 do 8 range to define sensitivity of the microwave sensor (1 - minimum; 8 – maximum).
8. Press #.
9. Enter a digit from the 1 do 4 range to define sensitivity of the dusk sensor (1 – minimum; 4 – maximum).
10. Press #.

APD-100 (APD-200)

1. Enter a number from the 0 to 50 range to define the rules of device presence control.
2. Press #.
3. Define whether the detector is to be always active by pressing any number key (· – no,  – yes).
4. Press #.
5. Enter a digit from the 1 to 3 range to define sensitivity (1 – low, 2 – medium, 3 – high).
6. Press #.

APD-100 (APD-200 Pet)

1. Enter a number from the 0 to 50 range to define the rules of device presence control.
2. Press #.
3. Define whether the detector is to be always active by pressing any number key (· – no,  – yes).
4. Press #.

5. Enter a digit from the 1 to 3 range to define sensitivity (1 – low, 2 – medium, 3 – high).
6. Press **#**.
7. When the pet immunity settings are displayed, press **#** (these settings are irrelevant).

APMD-150 (APMD-250)

1. Enter a number from the 0 to 50 range to define the rules of device presence control.
2. Press **#**.
3. Define whether the detector is to be always active by pressing any number key (· – no, **☑** – yes).
4. Press **#**.
5. Enter a digit from the 1 do 4 range to define sensitivity of the PIR sensor (1 – minimum; 4 – maximum).
6. Press **#**.
7. Enter a digit from the 1 do 8 range to define sensitivity of the microwave sensor (1 - minimum; 8 – maximum).
8. Press **#**.
9. Use the **▼** and **▲** keys to select how the detector will work in the test mode (PIR+MW, PIR or MW).
10. Press **#**.

ARD-100 (ARD-200)

1. Enter a number from the 0 to 50 range to define the rules of device presence control.
2. Press **#**.
3. Define whether the detector is to be always active by pressing any number key (· – no, **☑** – yes).
4. Press **#**.
5. Enter a number from the 1 to 16 range to define sensitivity (1 – minimum; 16 – maximum).
6. Press **#**.

ASD-150 (ASD-250)

1. Enter a number from the 0 to 50 range to define the rules of device presence control.
2. Press **#**.
3. Press any numeric key to define whether the detector is to signal alarm from other ASD-250 detectors (· – no, **☑** – yes).
4. Press **▼**.
5. Press any numeric key to define whether the detector is to send out alarm to other ASD-250 detectors (· – no, **☑** – yes).
6. Press **#**.

AVD-100 (AVD-200)

For the magnetic contact:

1. Enter a number from the 0 to 50 range to define the rules of device presence control.
2. Press **#**.
3. Define whether the detector is to be always active by pressing any number key (· – no, **☑** – yes).
4. Press **#**.
5. When the reed switch settings are displayed, press **#** (these settings are irrelevant).

For the shock detector:

1. Enter a digit from the 1 to 8 range to define sensitivity (1 – minimum; 8 – maximum).
2. Press **#**.
3. When the settings regarding the number of shocks are displayed, press **#** (these settings are irrelevant).

ASP-100 (ASP-200)

1. Enter a number from the 0 to 50 range to define the rules of device presence control.
2. Press **#**.
3. Use the **▼** and **▲** keys to select the type of acoustic signaling (see table 5).
4. Press **#**.
5. Use the **▼** and **▲** keys to define the maximum duration of signaling.
6. Press **#**.

ASP-205 (ASP-215)

You can program two different ways of signaling:

- having selected the first of the zones – signaling triggered by the first output controlling the siren,
- having selected the second of the zones – signaling triggered by the second output controlling the siren.

Configuration is similar for both zones, however, the step in which the rules of device presence control are defined is skipped for the second zone.

1. Enter a number from the 0 to 50 range to define the rules of device presence control.
2. Press **#**.
3. Use the **▼** and **▲** keys to define how the acoustic signaling will work (· – disabled; 1, 2 or 3 – type of acoustic signaling – see table 6).
4. Press **#**.
5. Use the **▼** and **▲** keys to define the maximum duration of signaling.
6. Press **#**.
7. Define whether the optical signaling is to be enabled (· – no, **☑** – yes).
8. Press **#**.

ASW-100 (ASW-200)

1. Enter a number from the 0 to 50 range to define the rules of device presence control.
2. Press **#**.
3. Use the **▼** and **▲** keys to define the way of control (“inactive” – only remote control; “interim control” – remote or manual control; “combined control” – remote or manual control, but with option to manually block the remote control).
4. Press **#**.

7.4 Specific character of the operation of wireless devices

When configuring the alarm system zones and outputs to which the wireless devices are assigned, you must take into account the specific character of operation of individual devices.

7.4.1 Wireless detectors

The zone to which a wireless detector is assigned is activated when the detector reports alarm (select the appropriate zone type). If a detector tamper is to trigger the tamper alarm, program the zone as 2EOL/NC or 2EOL/NO.

Operation of the detector is affected by the state of partition to which the zone belongs:

partition disarmed – the detector operates in **passive mode**. This operating mode prolongs the battery life. Detector informs the controller about its status during periodical communication (only the tamper information is sent immediately).

partition armed – the detector operates in **active mode**. Detector informs the controller about alarm or tamper immediately.

Switching the detector from passive mode to active and vice versa takes place during periodical communication. It results in a delay whose duration depends on the frequency of periodical communication (with the “ECO” option enabled, delay can be up to 3 minutes).

Detectors assigned to the zones that are always armed are permanently in the active mode.

For most detectors, you can enable the “Always active” option.



According to the EN50131-3 standard all ABAX 2 system Hold-Up devices must be always in active mode.

The battery life time in the detectors switched permanently into the active mode is shorter than in those which are periodically switched to the passive mode. However, if the specific character of a detector or its installation place is such that the number of alarms is low, switching the detector permanently into the active mode will not have a significant effect on the battery life.

7.4.2 Wireless sirens

Turning on the output to which the wireless siren is assigned will trigger the signaling. Depending on the siren:

ASP-200 – the first output controls the acoustic signaling, the second – the optical signaling. Thanks to a high-capacity battery, the siren can receive transmissions from the controller at any time. Therefore, the commands to start/stop signaling are sent to the siren immediately.

ASP-215 – both outputs can control the acoustic and optical signaling. This enables two different, independently triggered types of signaling to be configured. The outputs can control separately the acoustic and optical signaling or trigger other signaling for different alarms (e.g. burglary and fire). Given its low-capacity battery, the siren can receive transmissions from the controller during periodical communication only. Therefore, the commands to start/stop signaling are sent to the siren during periodical communication. Consequently, the operating time of outputs controlling the siren should be longer than the communication period.

The signaling will stop after the maximum signaling time expires, even if the output is still active.

The zones to which the wireless siren is assigned are activated if the signaling is triggered (select the appropriate zone type). If the siren tamper is to trigger tamper alarm, program the zone as 2EOL/NC or 2EOL/NO.

The tamper information is sent immediately, and the signaling state information – during periodical communication.

7.4.3 Wireless expanders of hardwired zones and outputs

You can configure the alarm system zone/output to which expander zone/output is assigned in much the same way as hardwired zones/outputs. You must, however, keep in mind that sensitivity of the expander zones may be different from that programmed in the control panel:

- from 20 ms to 140 ms – corresponds to sensitivity programmed in the control panel;
- above 140 ms – only some values are available: 400 ms, 500 ms, 700 ms, etc. every 200 ms (the programmed value is rounded up to that supported by the expander).



The EN50131-3 standard requires that zones must react to signals lasting more than 400 ms. Therefore, select 400 ms when programming sensitivity of the alarm zones.

Information on the state of zones and commands to change the state of outputs are sent immediately. Zone settings are sent during periodical communication.



If communication with the controller is lost, all previously activated outputs will be deactivated after 20 communication periods.

If the ACX-220 expander is powered from a power supply unit connected to the APS connector, the low battery information provided by the control panel means:

first zone – power supply overload,

second zone – low battery,

third zone – AC mains loss.

7.4.4 Wireless 230 V AC controllers

Turning on the output to which the controller is assigned turns on the relay controlling the 230 V AC circuit (turns on power).

The zone to which the wireless controller is assigned is activated when the relay controlling the 230 V AC circuit is turned on [operating modes 1 and 2] / ASW-200 controller button is pressed [operating mode 0] / ASW-210 controller input is activated [operating mode 0] (select the appropriate zone type).

7.4.5 Radio signal repeater

The first zone to which the radio signal repeater is assigned is activated in the event of 230 V AC mains loss (select the appropriate zone type).



The second zone to which the radio signal repeater is assigned is activated in the event of battery trouble (select the appropriate zone type).

If tamper of the radio signal repeater is to trigger tamper alarm, program the zone as 2EOL/NC or 2EOL/NO.

8 APT-200 keyfobs

The number of supported keyfobs depends on the number of control panel users.



Before adding a keyfob that was previously registered to the ABAX / ABAX 2 system, you must restart it (to do so, long press the  and  buttons for 30 seconds or remove the battery for 30 seconds).

The data related to keyfobs are stored in the controller. After the controller containing keyfob data is connected to the control panel, keyfobs will be automatically assigned to the existing users.

8.1 Keyfobs in the INTEGRA / INTEGRA Plus system

If two or more ABAX / ABAX 2 controllers are connected to the control panel, the keyfob will be supported by all of them. The keyfobs data are written automatically to all the controllers.

If you connect a controller to the INTEGRA 128-WRL control panel or a control panel to which an ABAX / ABAX 2 controller is already connected, the APT-200 keyfobs data must be unified. You can do it using:

- DLOADX program – in the “Keyfobs ABAX” window, click on the “Read” button and, immediately after the data are read, click on the “Write” button (after reading the data, you must not make any changes),

- LCD keyfob – use “Copy ABAX kfobs” function (service mode ▶ “Structure” ▶ “Hardware” ▶ “Expanders” ▶ “Copy ABAX kfobs”).



The controller does not support the APT-100 keyfobs.

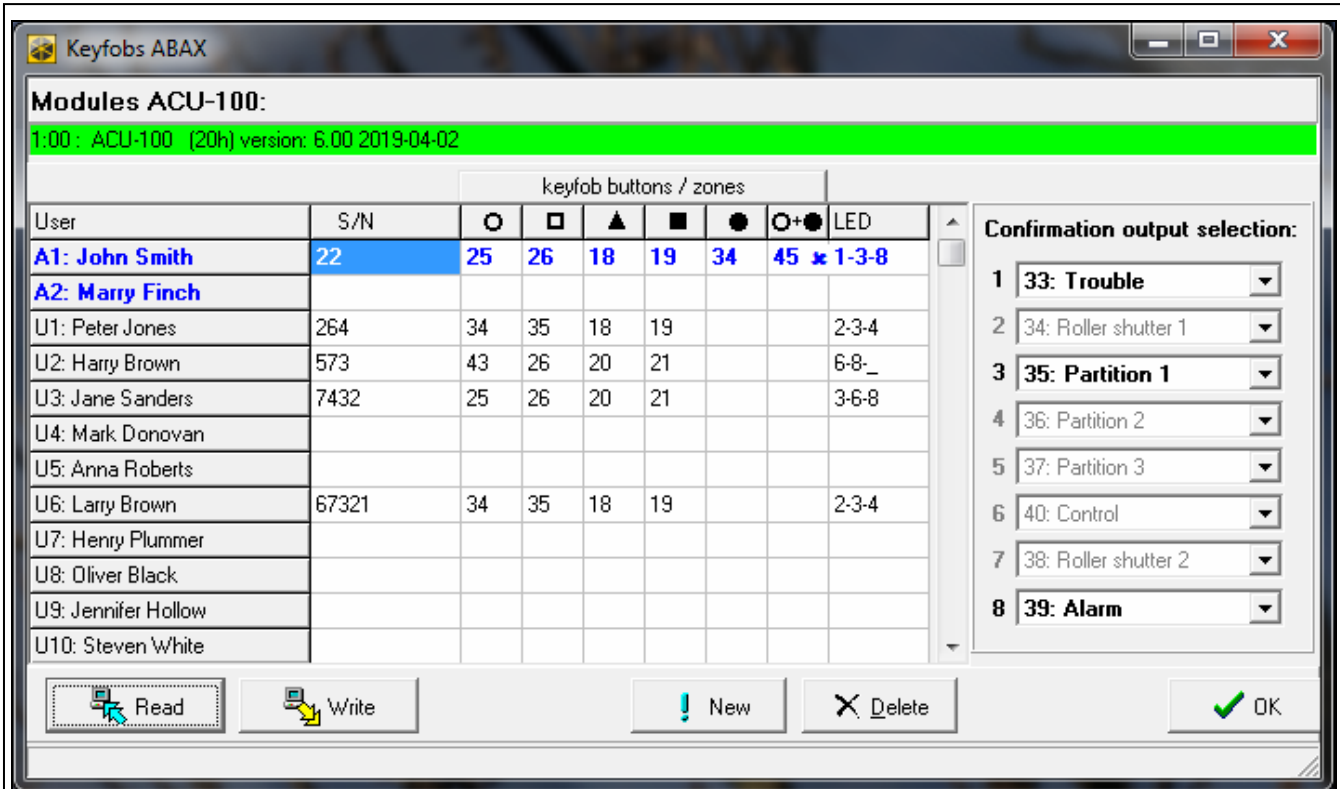

Fig. 12. DLOADX program: keyfob management when the controller is connected to INTEGRA / INTEGRA Plus control panel.

Using the keyfob, the user can control up to 6 zones of the alarm system. These zones should not exist physically and the wiring type programmed in them must be different from “No detector” and “Follow output”. You can select any type for these zones. Pressing a keyfob button(s) will violate the zone.

After pressing any keyfob button (which do not have to control any system zone), information about the state of three selected system outputs is indicated for a few seconds by the keyfob LEDs. Thus you can get confirmation that the function has been executed or information on the current system status. The outputs whose state is presented on the keyfob LEDs do not have to exist physically.

You can indicate up to 8 outputs in the system which will be used to inform the keyfob users (“Keyfobs ABAX” window in the DLOADX program or “ABAX confirmat.” function in the LCD-keypad (service mode ▶ “Structure” ▶ “Hardware” ▶ “Expanders” ▶ “ABAX confirmat.”)).

For information on adding / removing keyfobs by means of the keypad please refer to the control panel user manual.



Removing a keyfob only clears its serial number, but not its settings. If a new keyfob is added to the user, it will have the same settings as the removed one.

You can remove all keyfobs, including their settings, by means of the “Rem.ABAX keyfob” function available in the service mode in the keypad (▶ “Structure” ▶ “Hardware” ▶ “Expanders” ▶ “Rem.ABAX keyfob”).

8.1.1 Keyfob management using the DLOADX program

You can manage the keyfobs in the “Keyfobs ABAX” window (Fig. 12). The window opening command is available in the “Users” menu. Before making any changes, click on the “Read” button, and after making the changes – on the “Write” button (the data related to keyfobs are not read and saved after clicking on the  button in the program main menu).

Adding a keyfob

Entering the serial number manually

1. Click on the field in the “S/N” column next to the name of the user to whom you want to assign a keyfob.
2. Enter the keyfob serial number and press ENTER.

Reading the serial number during transmission

1. Click on the field in the “S/N” column next to the name of the user to whom you want to assign a keyfob.
2. Click on the “New” button.
3. The “New” window will open.
4. Press the keyfob button.
5. When the keyfob serial number is displayed in the window, click on the “OK” button.
6. The “New” window will close.
7. The serial number of the new keyfob will be shown in the “S/N” column.

Assigning a zone to keyfob button (combination of buttons)

1. Click on the field corresponding to the button (combination of buttons).
2. Enter the zone number and press ENTER.
3. Using the SPACE key enable/disable the event generating function. If the ✕ symbol is displayed next to the zone number, the event will not be saved after pressing the button / combination of buttons (if no symbol is displayed, the event will be saved).

Assigning outputs to the LEDs

1. Click on the field in the “LED” column.
2. Using the keyboard, enter up to 3 digits. Each of the digits must correspond to the number of field with output selected for confirmation (on the window right side) i.e. it can be from the 1 to 8 range. The names of outputs in fields designated with these digits will be shown in bold-type face.

Removing a keyfob

1. Click on the field in “S/N” column next to the name of user whose keyfob is to be removed.
2. Click on the “Delete” button.
3. The “Confirm” window will open.
4. Click on the “Yes” button.
5. The “Confirm” window will close.
6. The keyfob serial number shown in the “S/N” column will be erased.

8.2 Keyfobs in the VERSA / VERSA Plus / VERSA IP system

The functions which can be started using the keyfobs and the information that can be presented on the LEDs are described in manuals for the VERSA / VERSA Plus / VERSA IP control panels.

After a keyfob has been added, its settings will be configured automatically, based on the user schedule. These settings can be modified (different functions can be assigned to the buttons / combination of buttons and different information to the LEDs).



The user manual for VERSA / VERSA Plus / VERSA IP control panels describes the procedures for adding and editing the user by means of the keypad, during which you can add or remove the keyfob and program its settings.

i *Removing a keyfob only clears its serial number, but not its settings. If a new keyfob is added to the user, it will have the same settings as the removed one.*

You can remove all keyfobs, including their settings, by means of the “Rem.ABAX kfbs” function available in the service mode in the keypad (► “2.Hardware” ► “1.Kpds. & exps.” ► “8.Rem.ABAX kfbs”).

8.2.1 Keyfob management using the DLOADX program

You can add and delete keyfobs in the “Versa – Structure” window, “Hardware” tab, after clicking on the controller name in the list of devices, and then on the “Keyfobs” tab (Fig. 13). Before making any changes, click on the “Read” button, and after making the changes – on

the “Write” button (the data relating to keyfobs are not read after clicking on the  button or saved after clicking on the  button in the DLOADX program main menu).

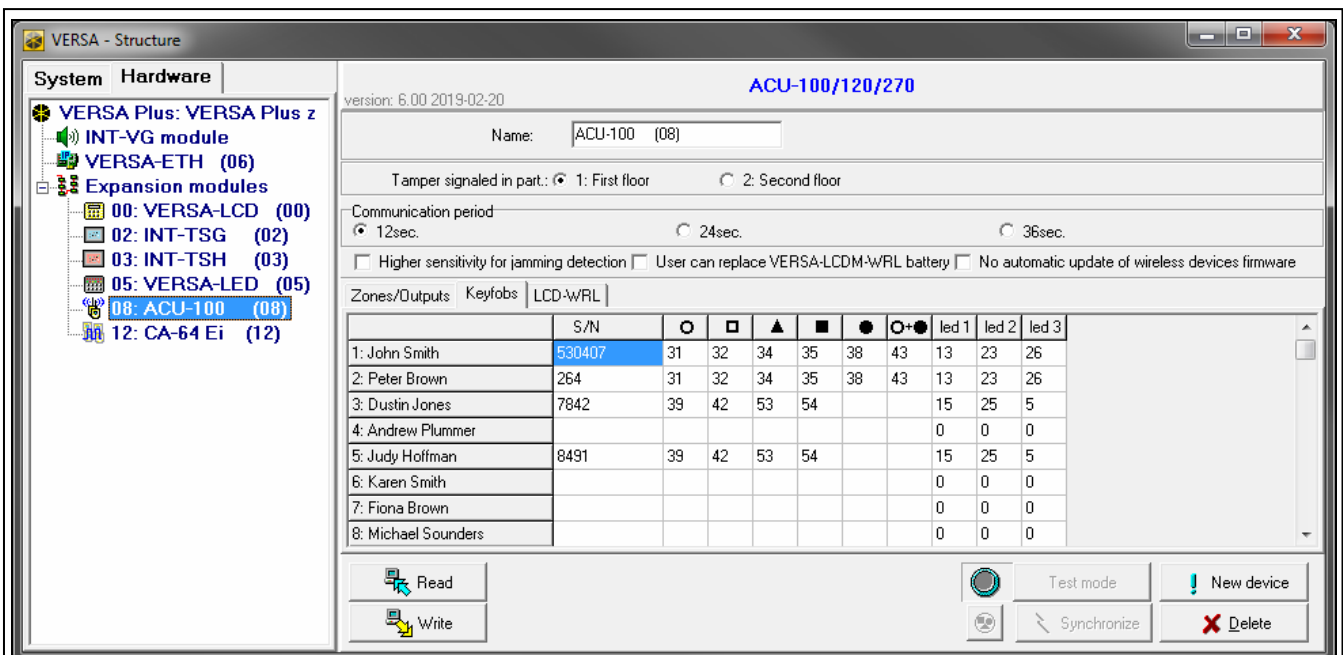

Fig. 13. DLOADX program: keyfob management when the controller is connected to VERSA / VERSA Plus / VERSA IP control panel.

Adding a keyfob

Entering the serial number manually

1. Click on the field in the “S/N” column next to the name of the user to whom you want to assign a keyfob.
2. Enter the keyfob serial number and press ENTER.

Reading the serial number during transmission

1. Click on the field in the “S/N” column next to the name of the user to whom you want to assign a keyfob.
2. Click on the “New device” button.
3. The “New” window will open.
4. Press the keyfob button.
5. When the keyfob serial number is displayed in the window, click on the “OK” button.
6. The “New” window will close.
7. The serial number of the new keyfob will be shown in the “S/N” column.

Assigning a function to keyfob button (combination of buttons)

1. Right click on the field corresponding to the button (combination of buttons).
2. The list of functions will be displayed.
3. Click on the function to be run by the keyfob button (combination of buttons).

Assigning information to a LED

1. Right click on the field corresponding to the LED.
2. The list of information that can be presented by the LED will be displayed.
3. Click on the information items to be presented.

Removing a keyfob

1. Click on the field in “S/N” column next to the name of user whose keyfob is to be removed.
2. Click on the “Delete” button.
3. The “Confirm” window will open.
4. Click on the “Yes” button.
5. The “Confirm” window will close.
6. The keyfob serial number shown in the “S/N” column will be erased.

9 ABAX 2 Soft program

The ABAX 2 Soft program enables diagnostics of the ABAX 2 wireless system. You can download the ABAX 2 Soft program from www.satel.eu website.

9.1 Description of the program

9.1.1 Menu bar in the program

The menu bar is displayed in the top part of the program window.



Fig. 14. ABAX 2 Soft program: menu bar.

- ① type of controller and firmware version.
- ② number of the computer port used for communication with the RS-232 (TTL) port of the controller.

When the ABAX 2 system is running in the test mode, the “TEST MODE” information is displayed on the menu bar (after the firmware version).

Buttons



click to establish connection to the controller. The button is displayed when the program is not connected to the controller.



click to finish connection to the controller. The button is displayed when the program is connected to the controller.



click to read data from the controller.



click to display additional menu.

9.1.2 Additional menu

The additional menu is displayed after you click on .

Open – click to open the controller data file.

Save – click to write the controller data to file.

Configuration – click to open the “Connection” window.

About – click to display information about the program.

“Connection” window

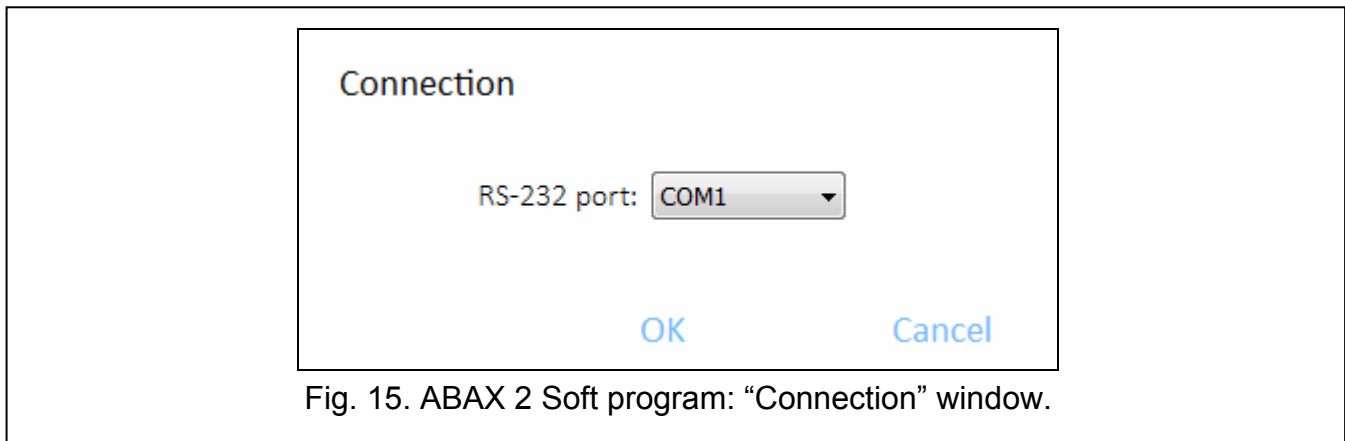



Fig. 15. ABAX 2 Soft program: “Connection” window.

Port RS-232 – computer COM port to be used for communication with the RS-232 (TTL) port of the controller.

OK – click to confirm the changes.

Cancel – click to close window without saving changes.

9.2 Establishing connection between the program and the controller

1. Connect the controller RS-232 (TTL) port with the computer port using the USB-RS converter offered by SATEL.
2. Select the computer COM port to be used for communication with the controller (see ““Connection” window” p. 36).
3. Click  on the menu bar.
4. After connection is established, information about the controller type and firmware version as well as the  button will be displayed on the program menu bar.

9.3 Status

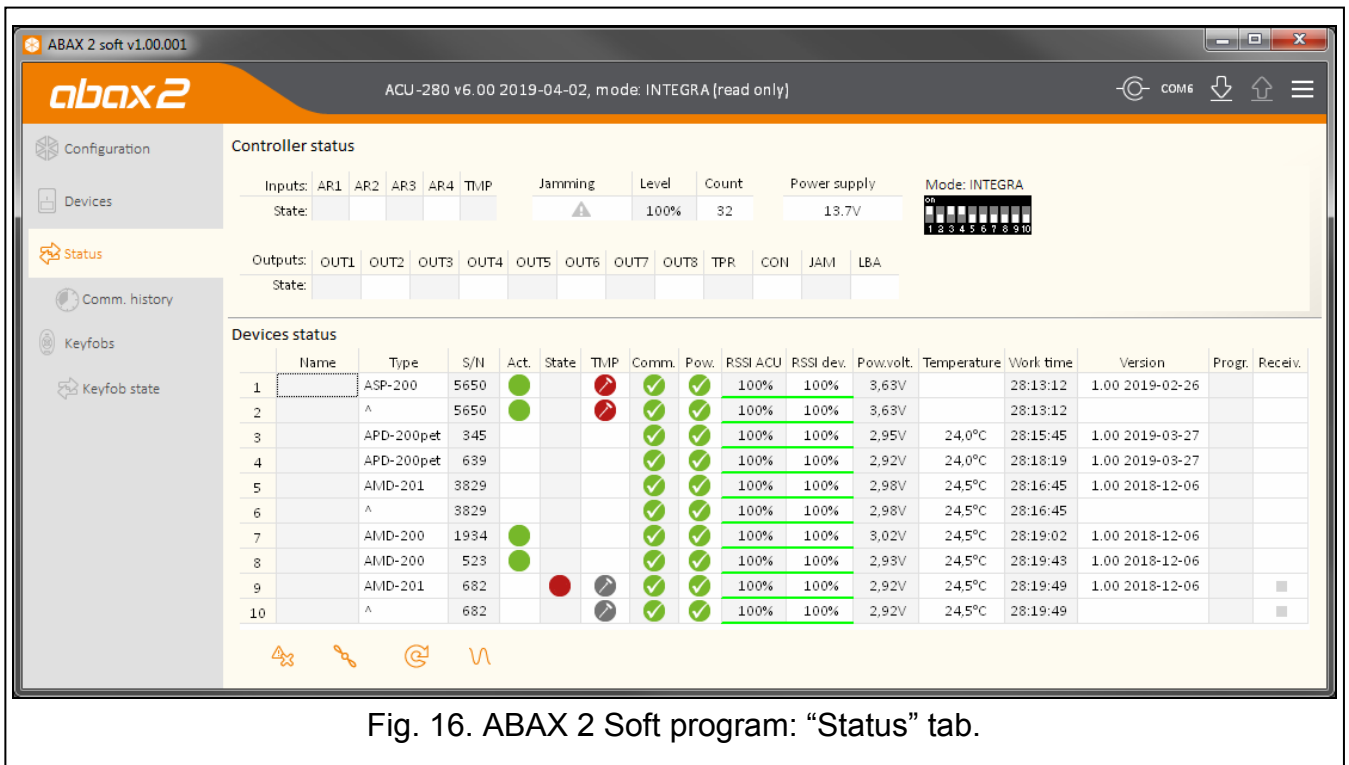

Fig. 16. ABAX 2 Soft program: “Status” tab.

Controller status

Jamming

Information about radio communication jamming:

- [yellow] – communication is jammed,
- [gray] – communication was jammed.

Level – level of radio communication jamming signal.

Count – number of radio communication jamming cases.

Power supply

Information about current voltage of the controller power supply.

DIP-switches

Graphic information about setting of DIP-switches.

Devices status

Name – blank field.

Type – device type. If the device takes up more than 1 position on the list, the “^” character is displayed in successive positions.



S/N – serial number of the device.

Act. – [green] icon indicates that:
 detector: working in active mode,
 another device: running.



State – [red] icon indicates that:
 detector: alarm,
 siren: signaling triggered,

expander of wired zones/outputs: input activated,
 ASW-200 controller: button pressed / relay turned on (230 V AC power ON),
 ASW-210 controller: input activated / relay turned on (230 V AC power ON).



TMP – tamper information:

-  [red] – tamper,
-  [gray] – tamper memory.

Comm. – information about radio communication between the device and the controller:

-  [green] – communication OK,
-  [yellow] – no communication for the time defined by the “Communication period” / “ECO” and “Filter” parameters,
-  [gray] – trouble memory.

Pow. – information about the state of device power supply:

-  [green] – power supply OK,
-  [yellow] – power trouble (e.g. low battery),
-  [gray] – power trouble memory.

RSSI ACU – level of the radio signal received from the device by the controller. Presented as percentage or in power units (dBm). Click twice on the column to change the way of presentation.

RSSI dev. – level of the radio signal received by the device from the controller. Presented as percentage or in power units (dBm). Click twice on the column to change the way of presentation.

Pow.volt. – value of the supply voltage.

Temperature – temperature registered by the temperature sensor in the device.





Work time – work time of the device. The time is counted from the moment of the device being registered to the controller, or restart of the device.

Version – firmware version of the device and build date. The orange font indicates that a new firmware version is available (see “Updating the firmware of ABAX 2 wireless devices” p. 41). The  [yellow] icon displayed in the field means that the firmware update attempts have failed.

Progr. – percentage value indicating progress of the device firmware update.

Receiv. – the  [black] icon indicates that the controller has just received a transmission from the device.

Buttons

- | | |
|---|--|
|  | click to clear trouble memory / restart the process of device firmware update. |
|  | click to start the test mode in the ABAX 2 system. |
|  | click to end the test mode in the ABAX 2 system. |
|  | click to refresh information about the supported devices. |
|  | click to display the graphs window (see “Graphs”). |

Graphs

Presented in the form of graphs are radio signal levels on four channels used by the ABAX 2 system. They allow you to check whether other radio devices that may interfere with

communication are working on this channel and what is the radio noise level. If there are any undesired radio signals which are comparable to or stronger than the signals from the ABAX 2 system, they will interfere with the system operation. This may result in a periodic loss of communication as well as quicker draining of the battery in wireless devices.

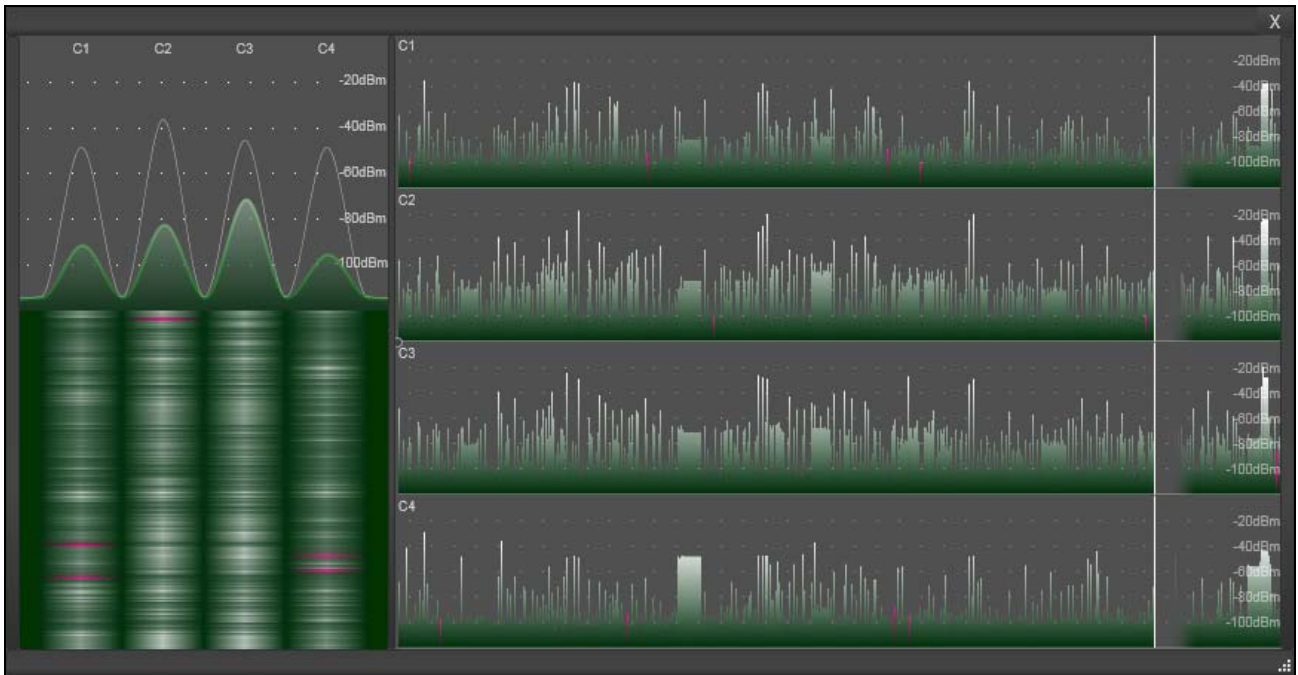

Fig. 17. ABAX 2 Soft program: “Graphs” window.

9.3.1 Comm. history

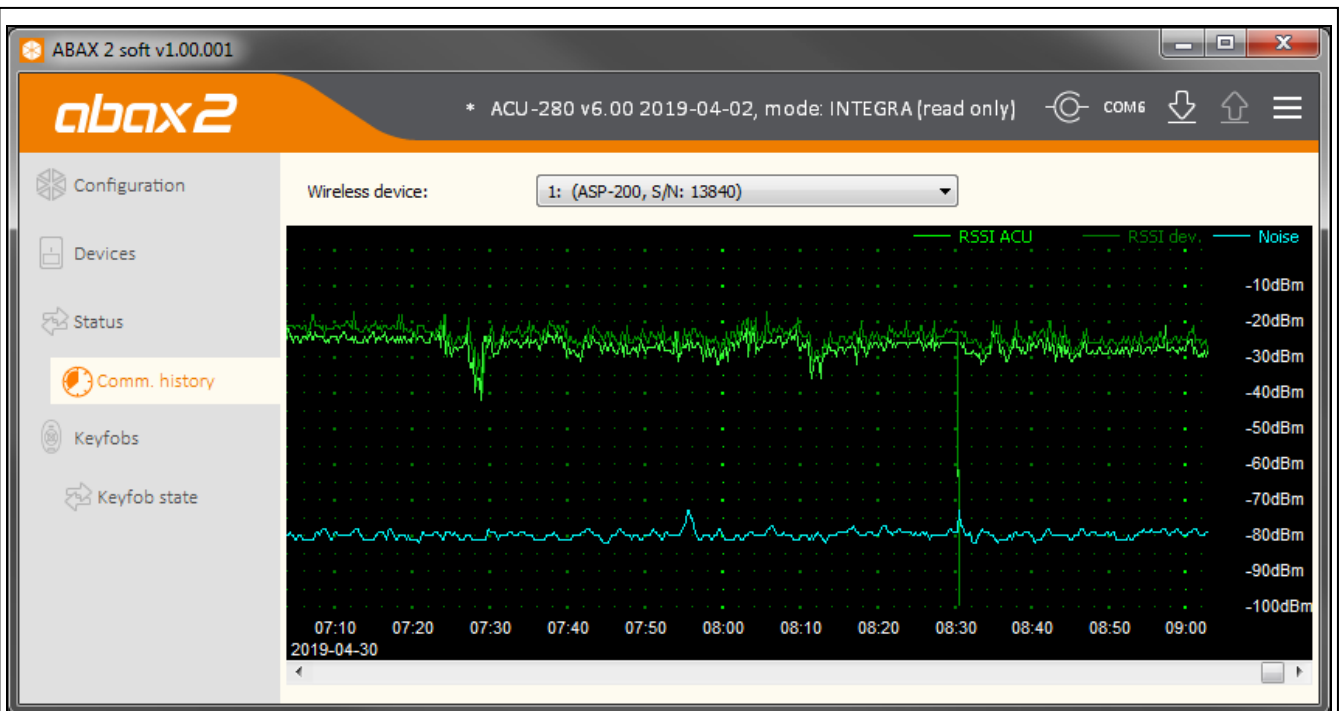
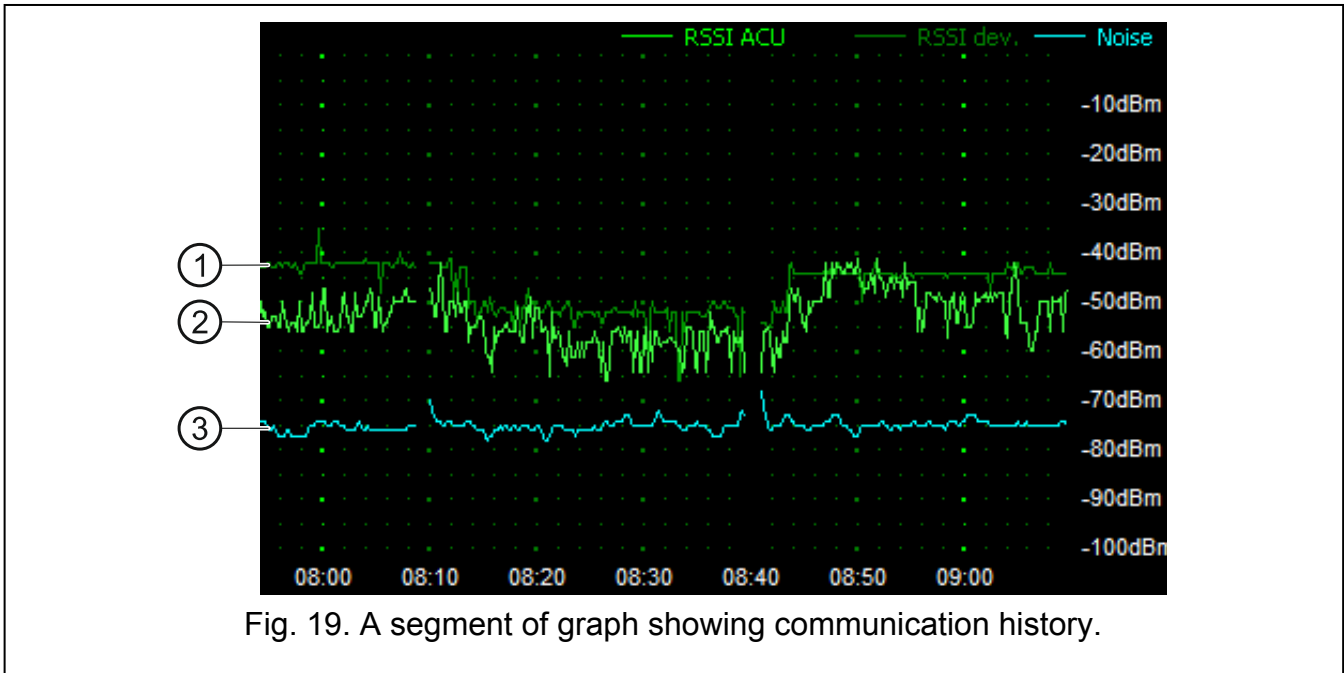

Fig. 18. ABAX 2 Soft program: “Comm. history” tab.

Wireless device – select a device from the list to display the graph showing the history of communication of that device with the controller.



The program collects data on communication history only when it is running.



Legend to Fig. 19:

- ① dark-green – level of the radio signal received by the device from the controller.
- ② light-green – level of the radio signal received from the device by the controller.
- ③ blue – level of the interfering signal.

Buttons



click to clear the history of communication of the selected device with the controller. This will display a window where you can define the period the data from which are to be cleared.

9.4 Keyfob state

	Name	S/N	Batt.	RSSI	Batt.volt.	Version	Progr.	Receiv.
1		5242	✓	-25dBm	3.02V	1.00 2019-01-14	6%	■
2		5250	✓	-23dBm	2.91V	1.00 2019-03-25		
3		7842	✓	-26dBm	3.02V	1.00 2019-03-25		
5		8491	✓	-23dBm	3.04V	1.00 2019-03-25		
241		67321	✓	-24dBm	2.98V	1.00 2019-03-25		

Fig. 20. ABAX 2 Soft Program: “Keyfob state” tab.

Name – blank field.

S/N – serial number of the keyfob.

Batt. – information about battery status:

 [green] – battery OK,

 [yellow] – low battery,

 [gray] – low battery memory.

RSSI – level of the radio signal received from the keyfob by the controller.

Batt.volt. – value of the battery voltage.

Version – keyfob firmware version and build date. The orange font indicates that a new firmware version is available (see “Updating the firmware of ABAX 2 wireless devices” p. 41). The  [yellow] icon displayed in the field means that the firmware update attempts have failed.

Progr. – percentage value indicating progress of the keyfob firmware update.

Receiv. – the  [black] icon indicates that the controller has just received a transmission from the device.

Buttons



click to clear trouble memory / restart the process of keyfob firmware update.



click to refresh information about the supported keyfobs.

10 Controller firmware update



When its firmware is being updated, the controller does not perform its normal functions.

Remember to save the controller settings to file before the firmware update.

1. Download the ACU-280 controller firmware update program from www.satel.eu.
2. Connect the RS-232 (TTL) port of the controller to the USB port of the computer. To make the connection, use the USB-RS converter, offered by SATEL.
3. Run the module firmware update program.
4. Click on the  button.
5. When the connection configuration window opens, select the computer COM port through which communication with the controller RS-232 (TTL) port is to take place.
6. When the prompt is displayed asking you whether to continue the firmware update, click “Yes”. The controller firmware will be updated.

10.1 Updating the firmware of ABAX 2 wireless devices

During the controller firmware update, programs enabling the update of the firmware of ABAX 2 system devices are also saved to the controller memory. If devices with outdated versions of firmware are registered in the controller, their firmware is updated by the controller automatically. The process of verification of the firmware of registered devices is run after each controller firmware update, as well as after adding new devices.

If attempts to automatically update the firmware of devices fail (e.g. as a result of radio signal interference or problems with the device power supply), the  icon will be displayed in the

ABAX 2 Soft program at the device firmware version. You can then click on the  button (see “Devices status” p. 37 and “Keyfob state” p. 40) to restart the update process.



At the final phase of the firmware update, the device does not perform its normal functions for a few seconds.

If you do not want the controller to automatically update the firmware of the devices registered in it, enable the “No automatic update of wireless devices firmware” option in the controller.

11 Restoring the controller factory settings

1. Power off the controller.
2. If wires are connected to the controller communication bus, disconnect them.
3. Short together the terminals CKE and DTE.
4. Power on the controller. The LED indicating the status of communication with the control panel will start blinking.
5. When the factory default settings are restored, the LED will go off for a while and then it will go on with steady light.
6. Open the terminals CKE and DTE.
7. Power off the controller.
8. Reconnect the wires to the controller communication bus.
9. Power on the controller.

12 Specifications

Operating frequency band.....	868.0 MHz ÷ 868.6 MHz
Radio communication range (in open area)	up to 1600 m
Supply voltage	12 V DC ±15%
Standby current consumption	55 mA
Maximum current consumption	60 mA
Security grade according to EN50131-3	Grade 2
Complied with standards. EN 50130-4, EN 50130-5, EN 50131-1, EN 50131-3, EN 50131-5-3	
Environmental class according to EN50130-5	II
Operating temperature range.....	-10°C...+55°C
Maximum humidity	93±3%
Enclosure dimensions	24 x 135 x 29 mm
Weight.....	48 g