

# Installation Guide

6-Port 10/100Mbps Desktop Switch with 4-Port PoE+

## LED Explanation

### Power

On: Power on  
 Off: Power off

### PoE MAX

On:  $60\text{ W} \leq \text{Total power supply} < 67\text{ W}$   
 Flashing: Total power supply  $\geq 67\text{ W}$   
 Off: Total power supply  $< 60\text{ W}$

### Link/Act and PoE Status

On: Link present but no activity  
 Flashing: Transmitting/receiving data  
 Off: No link  
 On: Providing PoE power  
 Flashing: Current-overload/Short-circuit  
 Off: Not providing PoE power

## Switch Explanation

### Priority (Port 1-2)

Off: All the ports transmit data in the same priority.  
 On: Port 1 and 2 transmit data in a higher priority than other ports. When congestion occurs, packets which are transmitted by the ports with higher priority occupy the whole bandwidth.

### Extend (Port 1-4)

Off: Port 1-4 run at 10/100 Mbps and support PoE power supply up to 100 m away.  
 On: Port 1-4 run at 10 Mbps and support PoE power supply up to 250 m away.

## Connection

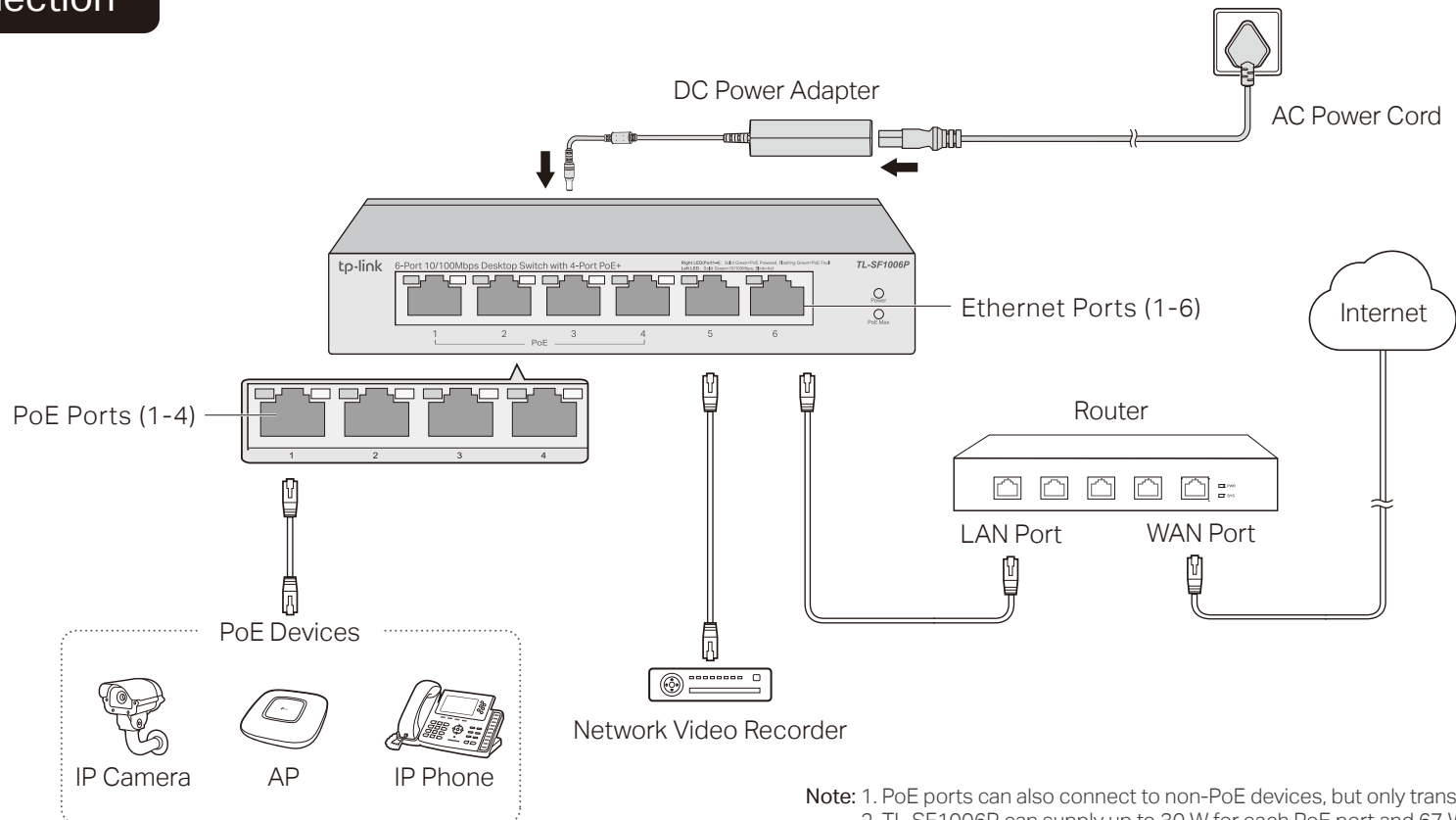

# Frequently Asked Questions (FAQ)

## Q1. Why is the Power LED not lit?

The Power LED should be lit when the power system is working normally. If the Power LED is not lit, please try the following:

- A1:** Make sure the AC power cord is connected to the switch with power source properly.
- A2:** Make sure the voltage of the power supply meets the requirements of the input voltage of the switch.
- A3:** Make sure the power source is on.

## Q2. Why is the Link/Act LED not lit while a device is connected to the corresponding port?

Please try the following:

- A1:** Make sure that the cable connectors are firmly plugged into the switch and the device.
- A2:** Make sure the connected device is turned on and works normally.
- A3:** The cable must be less than 100 meters long (328 feet).

## Q3. Why are PoE ports not supplying power for PoE devices?

When the total power consumption of connected PoE devices exceeds the maximum, the PoE port with a smaller port number has higher priority. The system will cut off power to the ports with larger port numbers to ensure supplying to other ports.

For example, if port 1, 2 and 4 are consuming 15.4 W respectively, and an additional PoE device with 21 W is inserted to port 3, the system will cut off the power of port 4 to compensate for the overload.



To ask questions, find answers, and communicate with TP-Link users or engineers, please visit <https://community.tp-link.com> to join TP-Link Community.



For technical support and other information, please visit <https://www.tp-link.com/support>, or simply scan the QR code.



If you have any suggestions or needs on the product guides, welcome to email [techwriter@tp-link.com.cn](mailto:techwriter@tp-link.com.cn).



# Specifications

## General Specifications

Standard	IEEE 802.3i, IEEE 802.3u, IEEE 802.3x, IEEE802.1p, IEEE 802.3af, IEEE 802.3at
Protocol	CSMA/CD
Interface	6 10/100 Mbps RJ45 Ports, Auto-Negotiation MDI/MDIX PoE Ports: Port 1-Port 4 PoE Power Budget: 67 W
Network Media (Cable)	10BASE-T: UTP category 3, 4, 5 cable (maximum 100 m); EIA/TIA-568 100Ω STP (maximum 100 m) 100BASE-TX: UTP category 5, 5e cable (maximum 100 m); EIA/TIA-568 100Ω STP (maximum 100 m)
Switching Capacity	1.2 Gbps
MAC Address Table	2K
Transfer Method	Store-and-Forward
MAC Address Learning	Automatically learning, automatically aging External Power Adapter
Power Supply	Input: 100-240 VAC, 50/60 Hz Output: 53.5 VDC /1.31 A
Wall Mountable	Yes
Distance Between Mounting Holes	94 mm

## Environmental and Physical Specifications

Operating Temperature	0 °C to 40 °C (32 °F to 104 °F)
Storage Temperature	-40 °C to 70 °C (-40 °F to 158 °F)
Operating Humidity	10% to 90%RH non-condensing
Storage Humidity	5% to 90%RH non-condensing

## PoE Disclaimer

The speed of the ports in extend mode will downgrade to 10 Mbps. The actual transmission distance may vary due to power consumption of PoE-powered devices or the cable quality and type.

PoE budget calculations are based on laboratory testing. Actual PoE power budget is not guaranteed and will vary as a result of client limitations and environmental factors.



## EU Declaration of Conformity

TP-Link hereby declares that the device is in compliance with the essential requirements and other relevant provisions of directives 2014/30/EU, 2014/35/EU, 2009/125/EC, 2011/65/EU and (EU)2015/863.

The original EU declaration of conformity may be found at <https://www.tp-link.com/en/ce>.

## Safety Information

- Keep the device away from water, fire, humidity or hot environments.
- Do not attempt to disassemble, repair, or modify the device.
- Do not use damaged charger or USB cable to charge the device.
- Do not use any other chargers than those recommended.
- Adapter shall be installed near the equipment and shall be easily accessible.
- Place the device with its bottom surface downward.
-  Use only power supplies which are provided by manufacturer and in the origin packing of this product. If you have any questions, please don't hesitate to contact us.



Продукт сертифіковано згідно з правилами системи УкрСЕПРО на відповідність вимогам нормативних документів та вимогам, що передбачені чинними законодавчими актами України.

## FC FCC compliance information statement

Product Name: Gigabit Desktop Switch  
Model Number: TL-SF1006P

Component Name	Model
I.T.E. POWER SUPPLY	T535131-2-DT

### Responsible party:

TP-Link USA Corporation, d/b/a TP-Link North America, Inc.  
Address: 145 South State College Blvd. Suite 400, Brea, CA 92821  
Website: <https://www.tp-link.com/us/>  
Tel: +1 626 333 0234  
Fax: +1 909 527 6803  
E-mail: [sales.usa@tp-link.com](mailto:sales.usa@tp-link.com)

This equipment has been tested and found to comply with the limits for a Class A digital device, pursuant to part 15 of the FCC Rules. These limits are designed to provide reasonable protection against harmful interference when the equipment is operated in a commercial environment. This equipment generates, uses, and can radiate radio frequency energy and, if not installed and used in accordance with the instruction manual, may cause harmful interference to radio communications. Operation of this equipment in a residential area is likely to cause harmful interference in which case the user will be required to correct the interference at his own expense. • Reorient or relocate the receiving antenna.

This device complies with part 15 of the FCC Rules. Operation is subject to the following two conditions:

- 1) This device may not cause harmful interference.
- 2) This device must accept any interference received, including interference that may cause undesired operation.

Any changes or modifications not expressly approved by the party responsible for compliance could void the user's authority to operate the equipment.

We, TP-Link USA Corporation, has determined that the equipment shown as above has been shown to comply with the applicable technical standards, FCC part 15. There is no unauthorized change is made in the equipment and the equipment is properly maintained and operated.

Issue Date: 2020.3.9

## CE CE Mark Warning

This is a class A product. In a domestic environment, this product may cause radio interference, in which case the user may be required to take adequate measures.

## BSMI Notice

### 安全諮詢及注意事項

- 請使用原裝電源供應器或只能按照本產品注明的電源類型使用本產品。
- 清潔本產品之前請先拔掉電源線。請勿使用液體、噴霧清潔劑或濕布進行清潔。
- 注意防潮，請勿將水或其他液體潑灑到本產品上。
- 插槽與開口供通風使用，以確保本產品的操作可靠並防止過熱，請勿堵塞或覆蓋開口。
- 請勿將本產品置放於靠近熱源的地方。除非有正常的通風，否則不可放在密閉位置中。
- 請不要私自拆開機殼或自行維修，如產品有故障請與原廠或代理商聯繫。

### 限用物質含有情況標示聲明書

產品元件名稱	限用物質及其化學符號					
	鉛 Pb	鎘 Cd	汞 Hg	六價鉻 Cr <sup>6+</sup>	多溴聯苯 PBB	多溴二苯醚 PBDE
PCB	○	○	○	○	○	○
外殼	○	○	○	○	○	○
電源供應器	—	○	○	○	○	○

備考1. “○”系指該項限用物質之百分比含量未超出百分比含量基準值。  
備考2. “—”系指該項限用物質為排除項目。

## FC FCC compliance information statement

Product Name: I.T.E. POWER SUPPLY  
Model Number: T535131-2-DT

### Responsible party:

TP-Link USA Corporation, d/b/a TP-Link North America, Inc.  
Address: 145 South State College Blvd. Suite 400, Brea, CA 92821  
Website: <https://www.tp-link.com/us/>  
Tel: +1 626 333 0234  
Fax: +1 909 527 6803  
E-mail: [sales.usa@tp-link.com](mailto:sales.usa@tp-link.com)

This equipment has been tested and found to comply with the limits for a Class A digital device, pursuant to part 15 of the FCC Rules. These limits are designed to provide reasonable protection against harmful interference when the equipment is operated in a commercial environment. This equipment generates, uses, and can radiate radio frequency energy and, if not installed and used in accordance with the instruction manual, may cause harmful interference to radio communications. Operation of this equipment in a residential area is likely to cause harmful interference in which case the user will be required to correct the interference at his own expense.

This device complies with part 15 of the FCC Rules. Operation is subject to the following two conditions:

- 1) This device may not cause harmful interference.
- 2) This device must accept any interference received, including interference that may cause undesired operation.

Any changes or modifications not expressly approved by the party responsible for compliance could void the user's authority to operate the equipment.

We, TP-Link USA Corporation, has determined that the equipment shown as above has been shown to comply with the applicable technical standards, FCC part 15. There is no unauthorized change is made in the equipment and the equipment is properly maintained and operated.

Issue Date: 2020.3.9

## Mounting Requirements





To mount the device on a wall, use 2 screws which complies with ANSI B1.1 4#, (5#), 6#, 8# standard and are more than 8.5 mm in length. When the screws are fixed on the wall, the distance between the screw head and the wall should be more than 1.5 mm.

Standard	Diameter
ANSI B1.1 #4	2.845 mm
ANSI B1.1 #5	3.175 mm
ANSI B1.1 #6	3.505 mm
ANSI B1.1 #8	4.166 mm

## Industry Canada Statement

CAN ICES-3 (A)/NMB-3(A)

## Explanation of the symbols on the product label

	DC voltage
	Indoor use only
	RECYCLING This product bears the selective sorting symbol for Waste electrical and electronic equipment (WEEE). This means that this product must be handled pursuant to European directive 2012/19/EU in order to be recycled or dismantled to minimize its impact on the environment. User has the choice to give his product to a competent recycling organization or to the retailer when he buys a new electrical or electronic equipment.
	Polarity of output terminals
	Energy efficiency Marking (Level VI)