

The module's features:

- 10 ÷ 14V DC power supply
- Activation of the relay for the T2 time after the T1 trigger time
- time range from 1 second to 5 min.
- Relay output
- Activated by plus "S +" or ground (minus) „S-„
- Reset input activated by the "R-" ground (minus)
- Optical indication of power supply, triggering signal and relay output status
- Warranty - 2 years from the production date

CONTENTS.

- 1. General description**
- 2. Components arrangement**
- 3. Specifications**

1. General description.

The PC4 time module is a transceiver that allows Activation of the relay for the T2 time after the T1 trigger time. The T1 and T2 times can be adjusted in the range from 1 second to 5 minutes.

The relay can be used in door opening circuits, locks, gate closing systems, alarm systems, Intrusion Detection Systems, Access control systems and many others.

2. Components arrangement.

The figure below shows the arrangement of the most important components and connectors of the relay module.

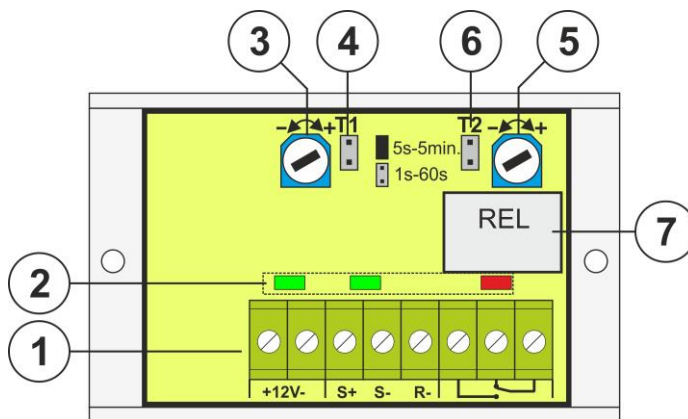











Fig.1. The view of the module.

Table 1. The description of components and connectors of the module.

No. [Fig.1]	Description
①	<p>Connector: +12V- - The module's power supply, DC voltage S+ - control input supplied by the positive power supply S- - control input activated by the negative power supply (power supply minus) R- - Reset input activated by the ground (power supply minus)</p>  <p>- REL relay connector</p> <p>CAUTION ! In Fig.1 the set of contacts shows a potential-free status of the relay.</p>
②	<p>LED (green): – optical indication green – supply voltage green – trigger signal indication (S + or S-) red – The REL relay activation indication – (the LED is on when the relay is activated)</p>
③	<p>Potentiometer for T1 trigger time adjustment</p>
④	<p>Time range jumper T1:  1s – 60s. time range  5s – 5 min. time range Description:  jumper on,  jumper on</p>
⑤	<p>Potentiometer for T2 relay activation time adjustment</p>
⑥	<p>Time range jumper T2:  1s – 60s. time range  5s – 5 min. time range Description:  jumper on,  jumper on</p>
⑦	<p>Relay</p>

3. Specifications.

Supply voltage	10÷14V DC
Power consumption	15 mA – inactive relay /35 mA - active relay (±5%)
S+ input	10÷14V DC control
S- input	0V (GND) control
R- input	0V (GND) control
Time range	Time T1: range 1s ÷ 60s and 5s ÷ 5min. Time T2: range 1s ÷ 60s and 5s ÷ 5min.
The number of relays	1
Maximum connection voltage	50V AC /30V DC
Maximum connection current	1 A
Maximum contact resistance	<100 mOhm
Optical indication of operation	LED light
Operation parameters	II environmental class, -10°C - 40°C, relative humidity 20%...90% No condensation.
Dimensions	69 x 43 x 21 (WxHxD)
Mounting	mounting tape or dowel pins x2 (holesØ3mm)
Connectors	Φ0,51±2,05 mm (AWG 24-12)
Net/gross weight	0,040 /0,060 [kg]

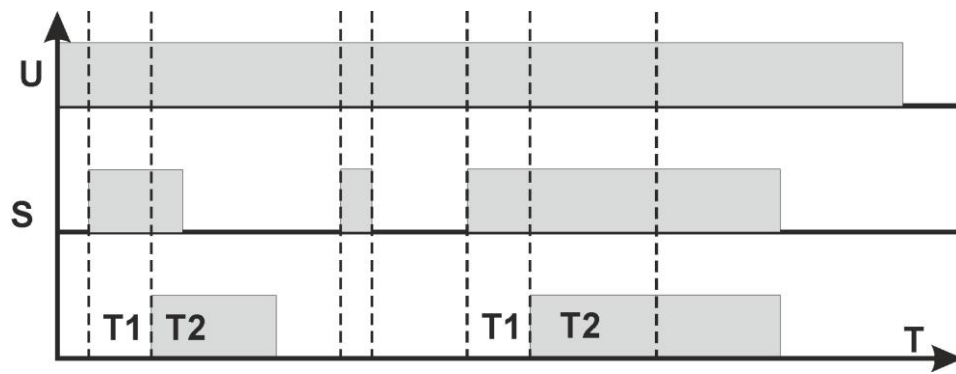

Fig.2 Time diagrams of the module.

WEEE LABEL

According to the European Union WEEE Directive, waste electrical and electronic equipment should be disposed of separately from normal household waste. Waste electrical and electronic equipment must not be disposed of with normal household waste.

WARRANTY

Pulsar (the manufacturer) grants a two -year warranty for the equipment, counted from the device's production date.

Pulsar

Siedlec 150, 32-744 Łapczyca, Poland
Tel. (+48) 14-610-19-40, Fax (+48) 14-610-19-50
E-mail: biuro@pulsar.pl, sales@pulsar.pl
http:// www.pulsar.pl, www.zasilacze.pl